

STC1000_0 Mechanical Drawing

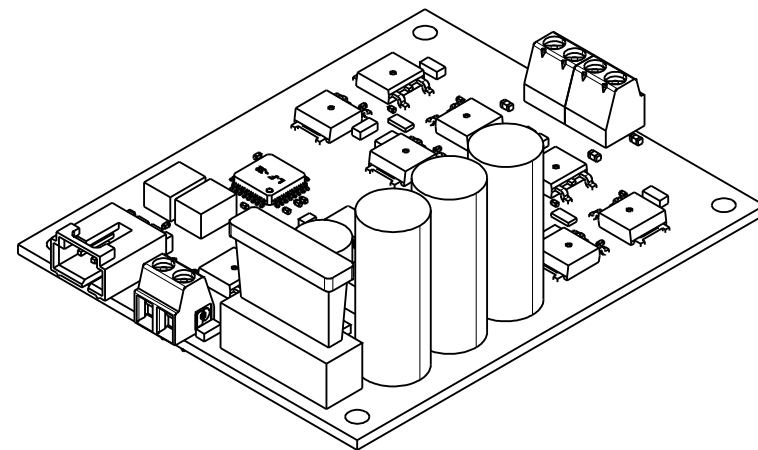

$\varnothing.125"$
[$\varnothing3.175$ mm]

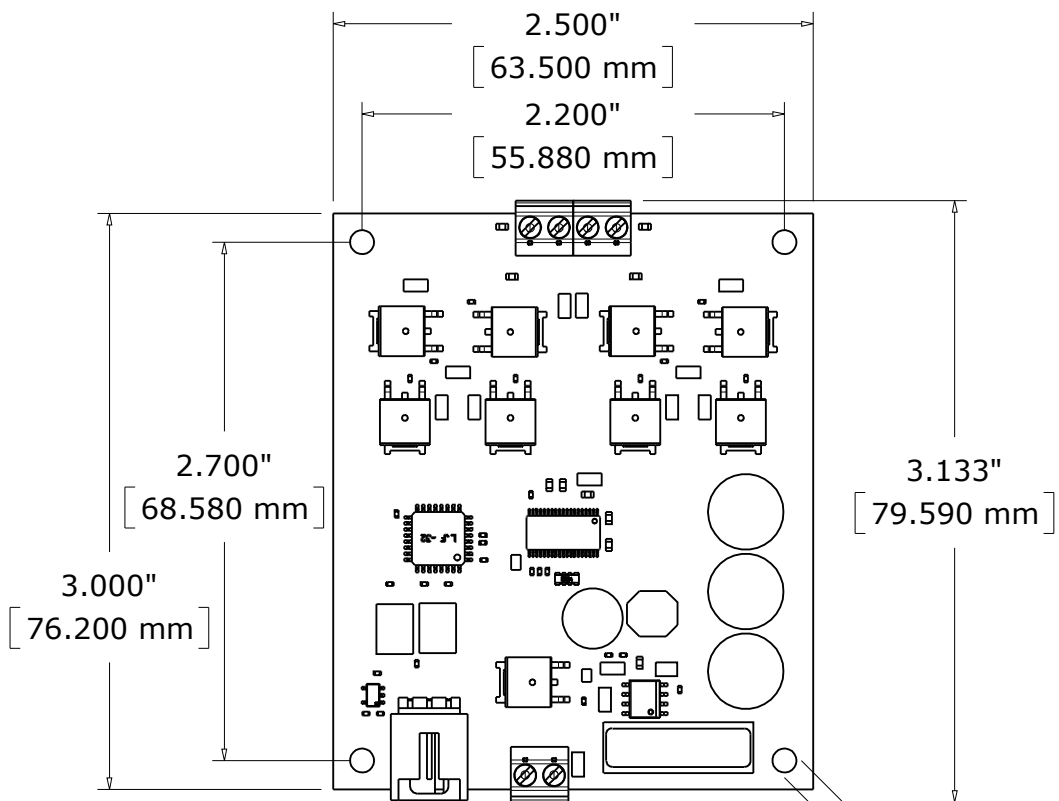
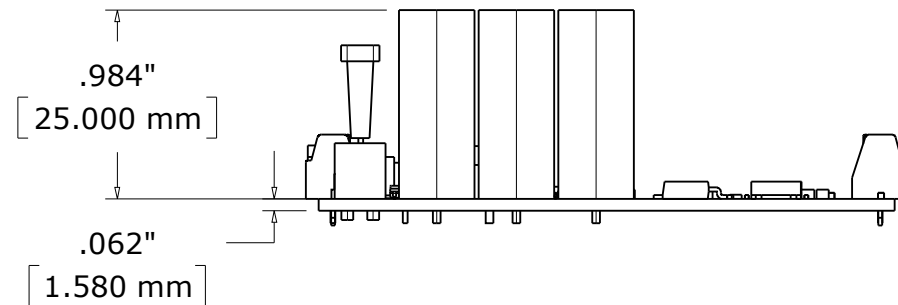
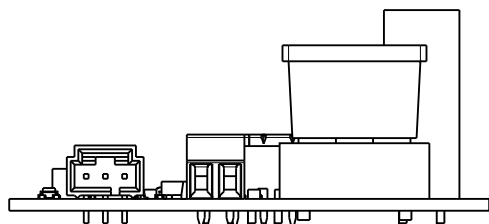

STC1000_0 Enclosure Mechanical Drawing

