

# REL2002\_0 Mechanical Drawing

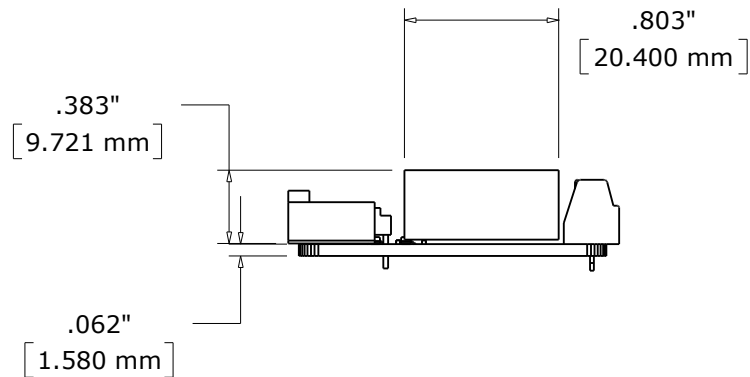

# REL2002\_0 Enclosure Mechanical Drawing

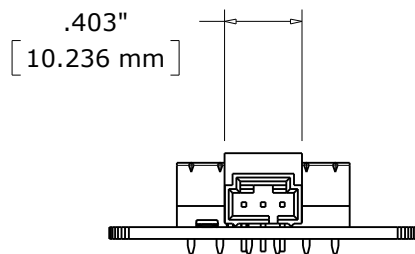
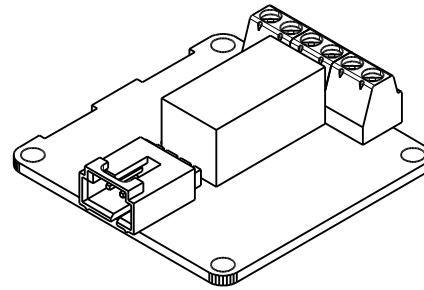
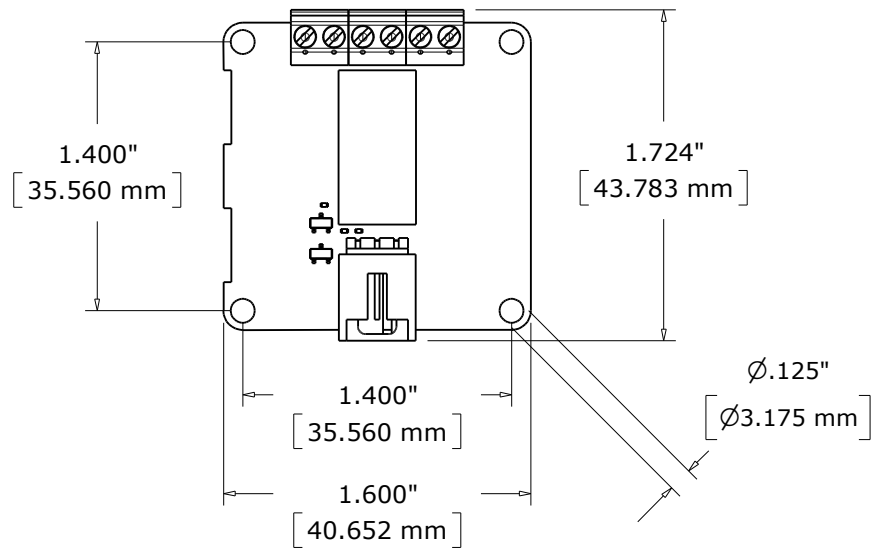