

OUT1001_0 Mechanical Drawing

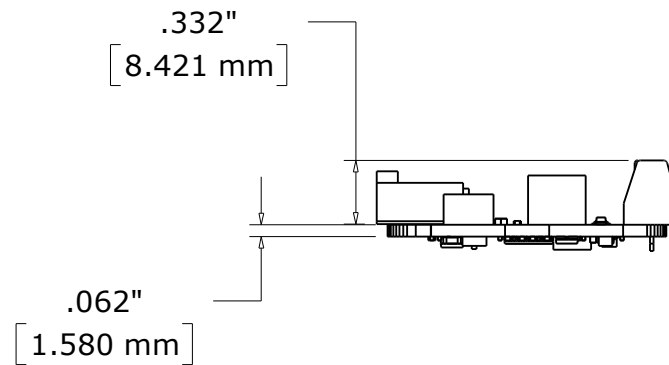

OUT1001_0 Enclosure Mechanical Drawing

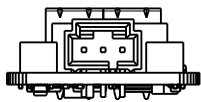
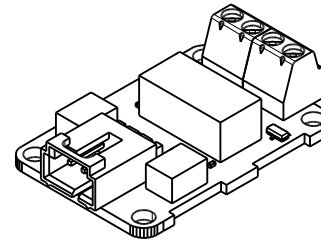
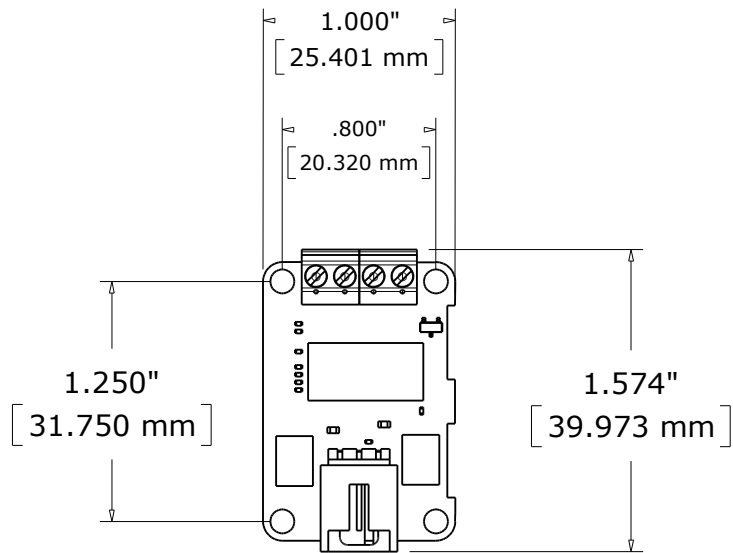