

# HIN1001\_0 Mechanical Drawing

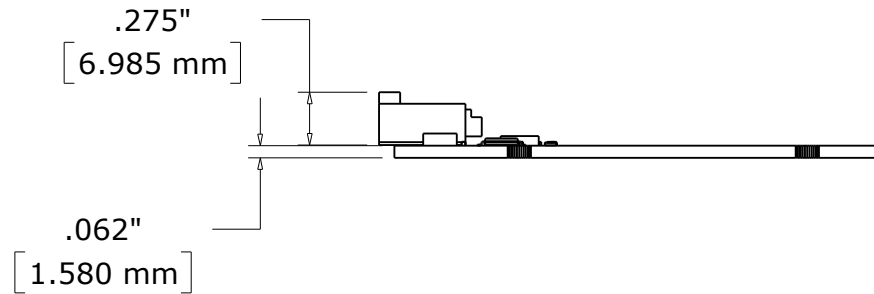

# HIN1001\_0 Enclosure Mechanical Drawing

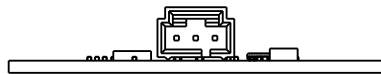
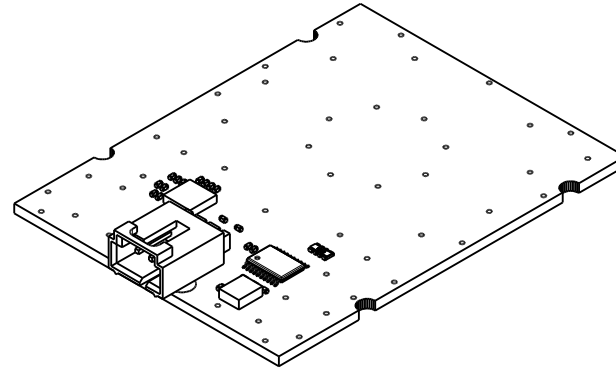
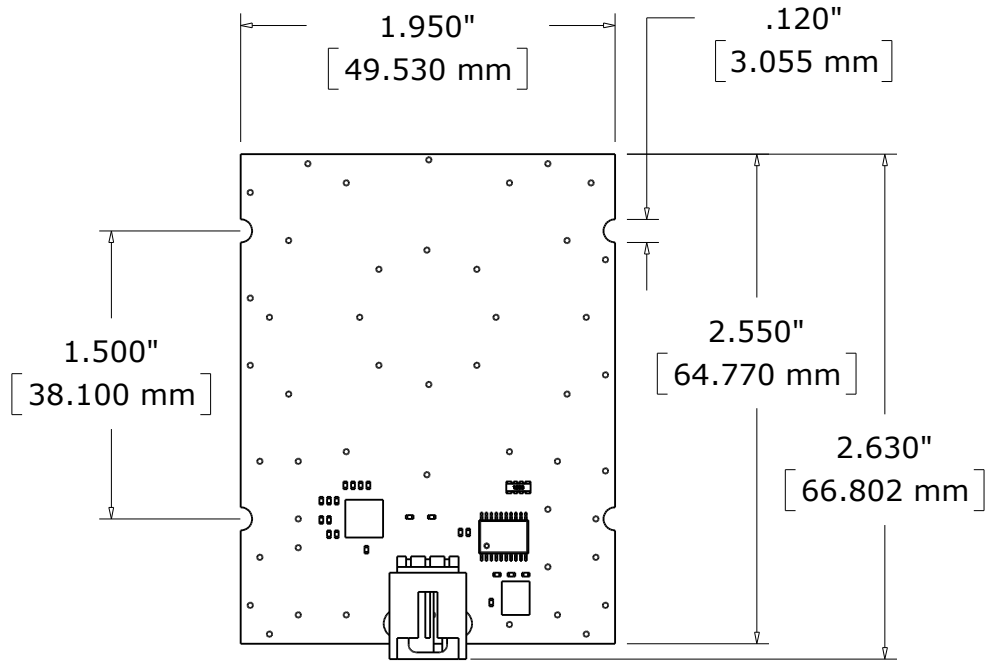