

# DCC1100\_1 Mechanical Drawing

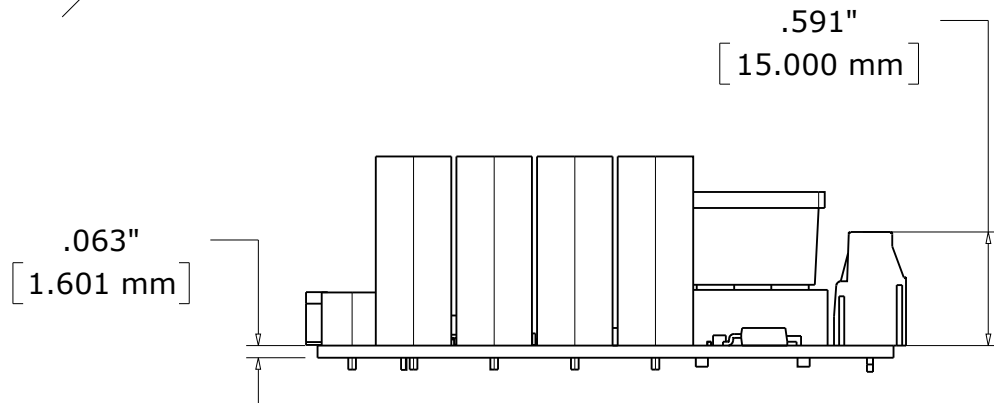

# DCC1100\_1 Enclosure Mechanical Drawing

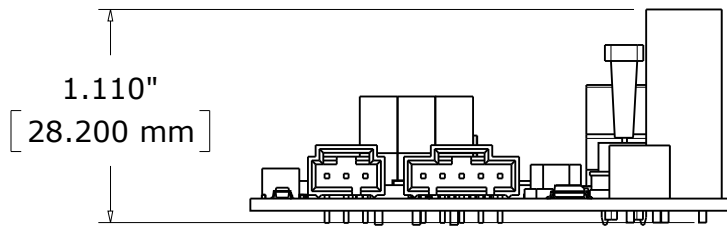
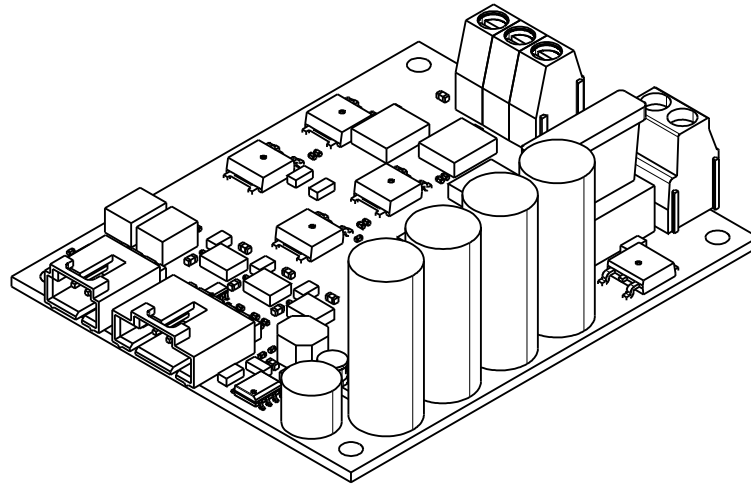
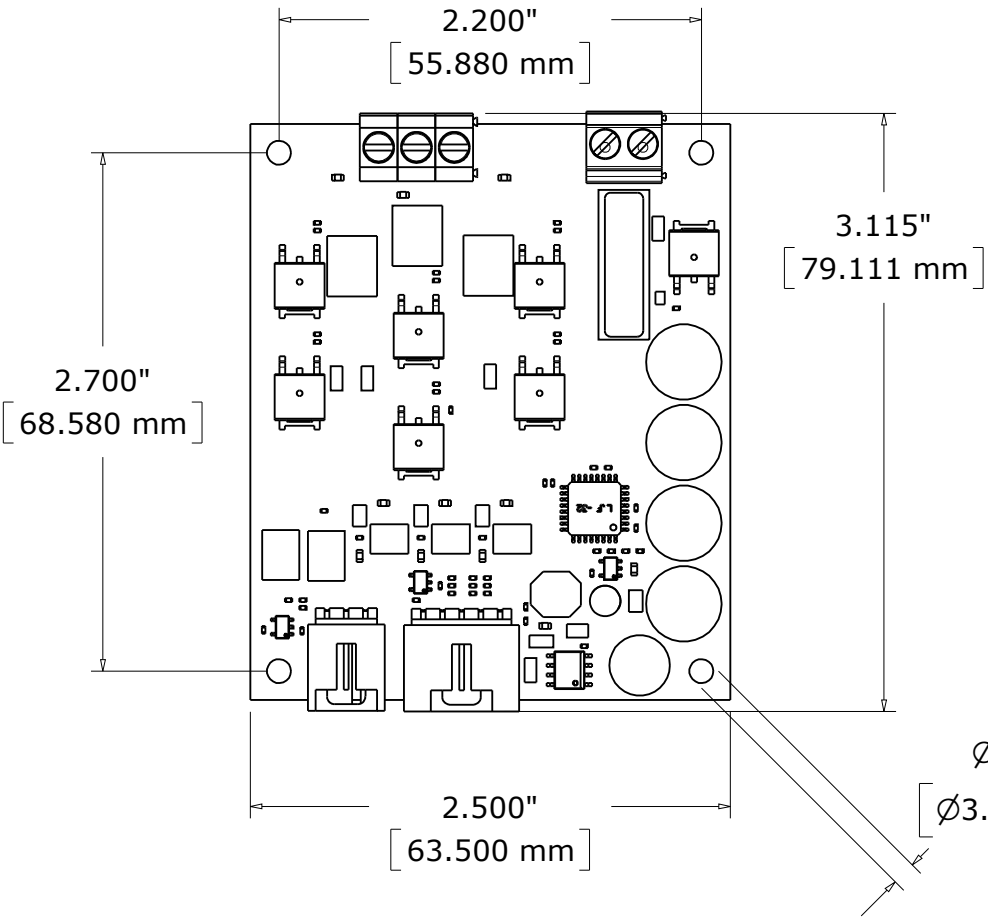