

# DCC1100\_0 Mechanical Drawing

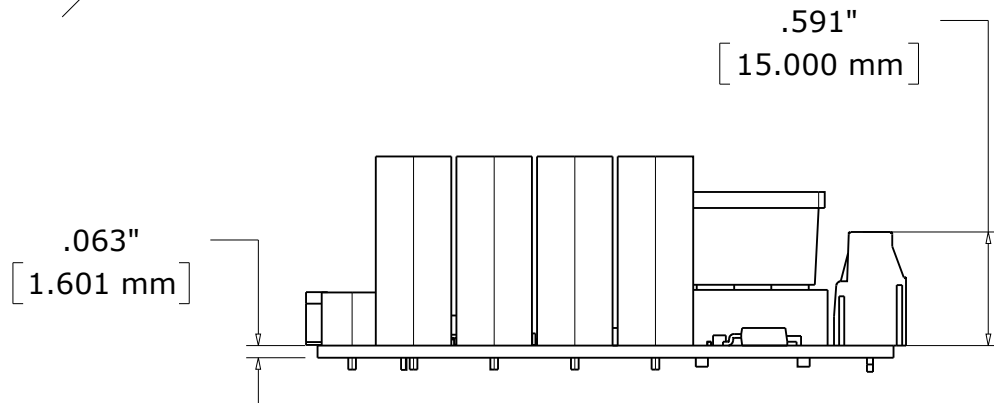

# DCC1100\_0 Enclosure Mechanical Drawing

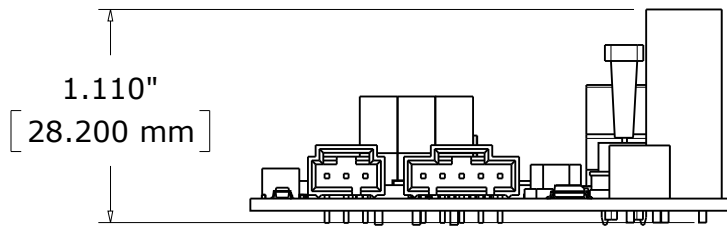
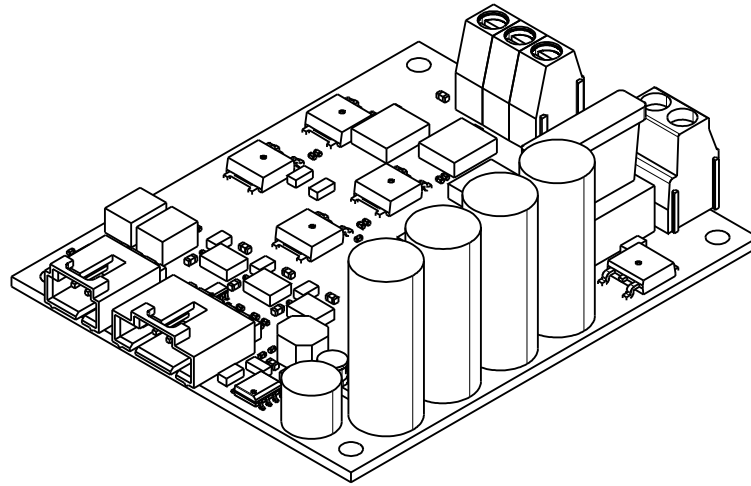
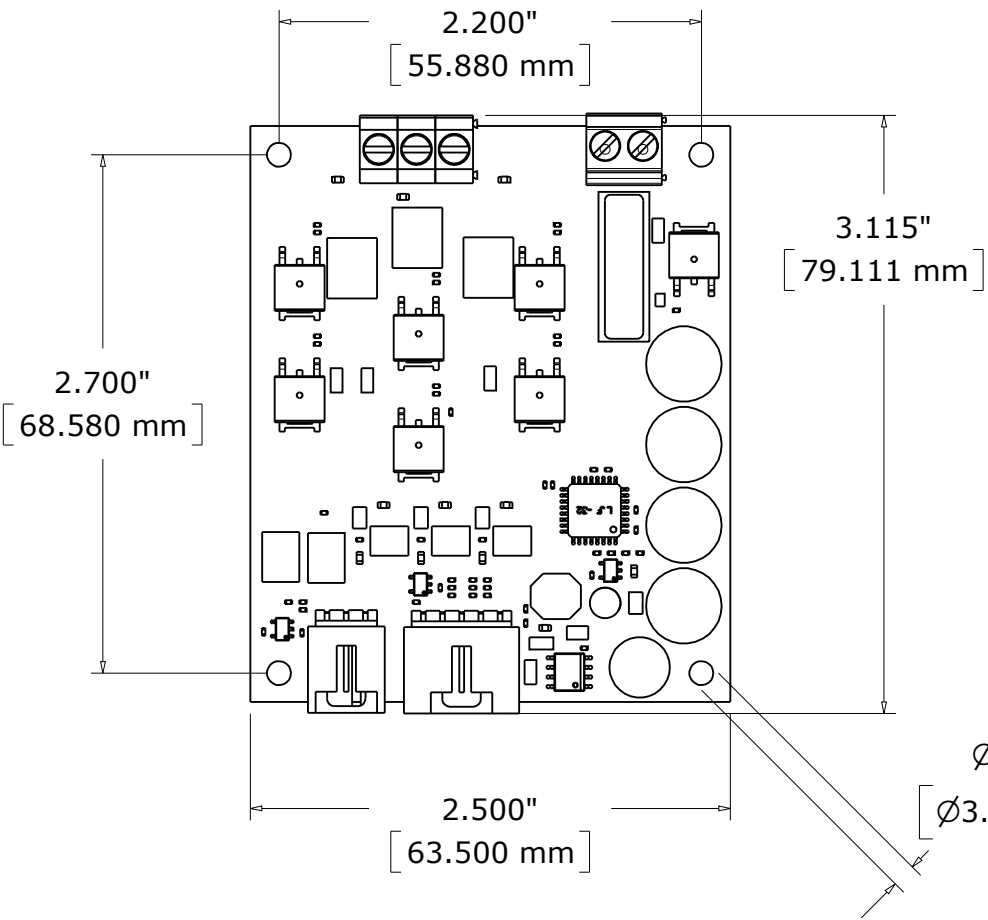