

# DCC1001\_0 Mechanical Drawing

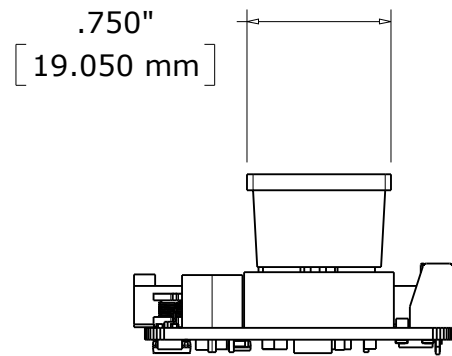

# DCC1001\_0 Enclosure Mechanical Drawing

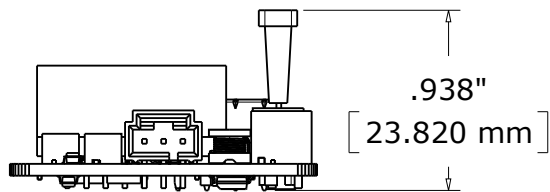
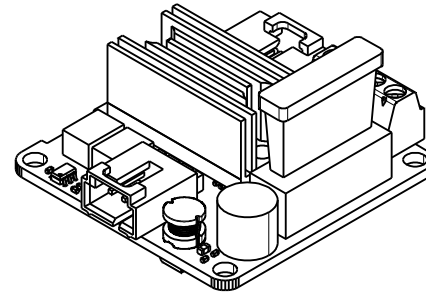
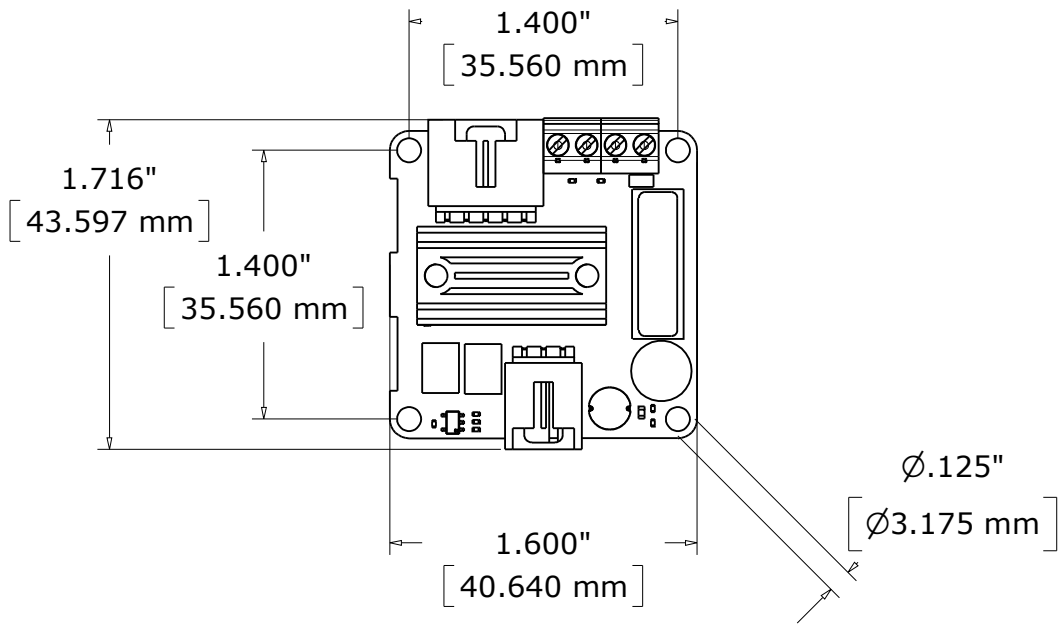