

DAQ1301_0 Mechanical Drawing

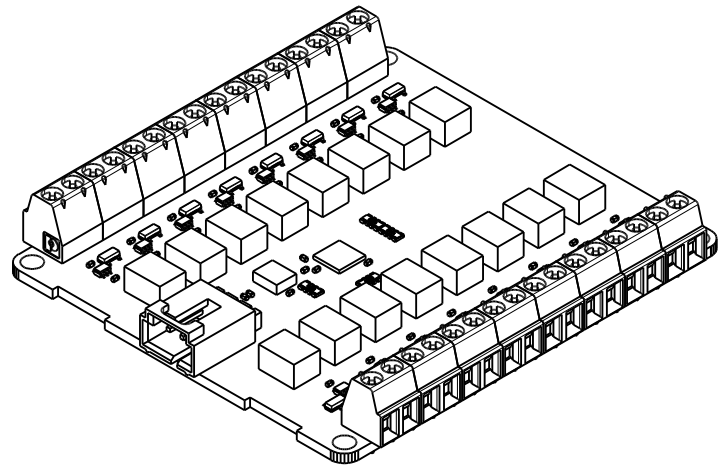

$\varnothing.125"$
[$\varnothing 3.175$ mm]

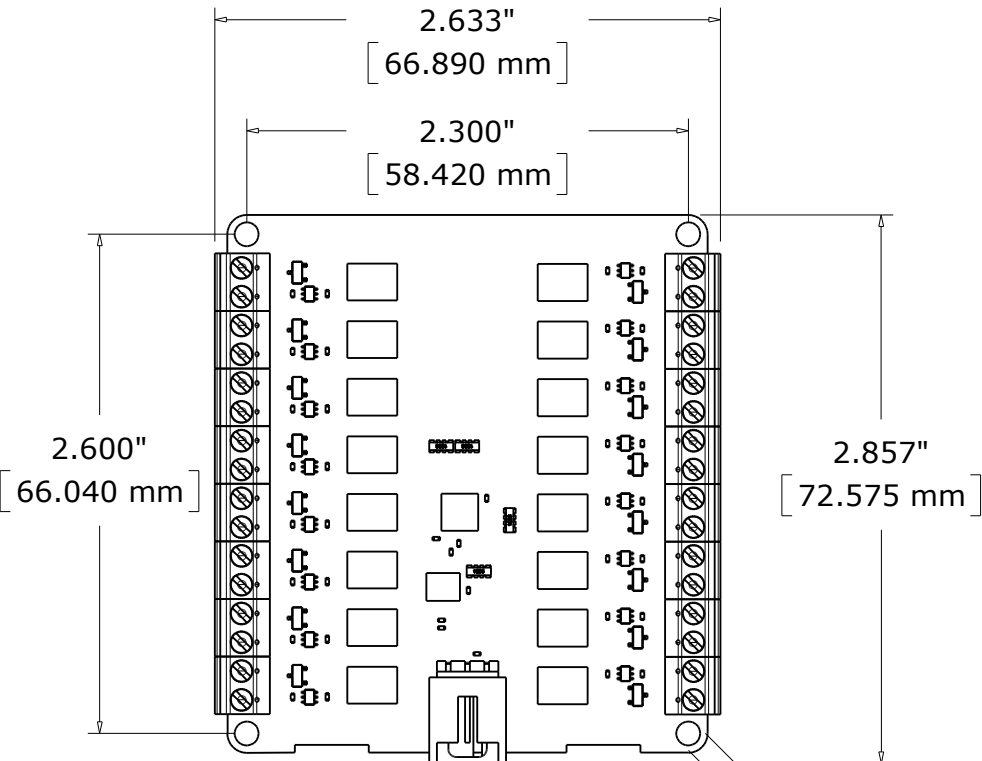
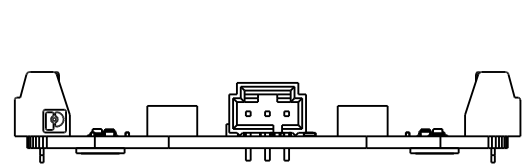

.332"
[8.421 mm]

.062"
[1.580 mm]

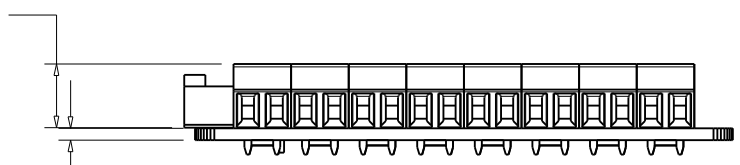

DAQ1301_0 Enclosure Mechanical Drawing

