

3852_0 Mechanical Drawing

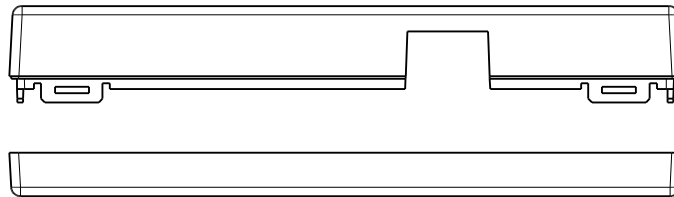
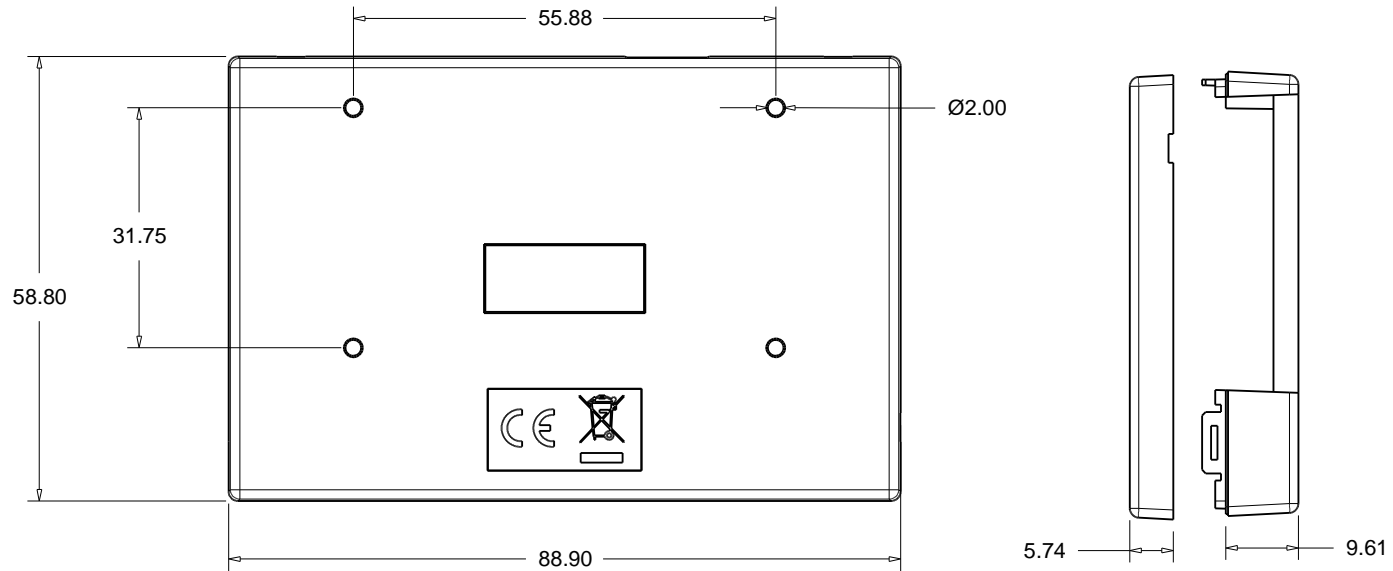

Dimensions are in mm