

# Phidget Enclosure Assembly Instructions

PN 3814 : Acrylic Enclosure for the 1055 PhidgetIR

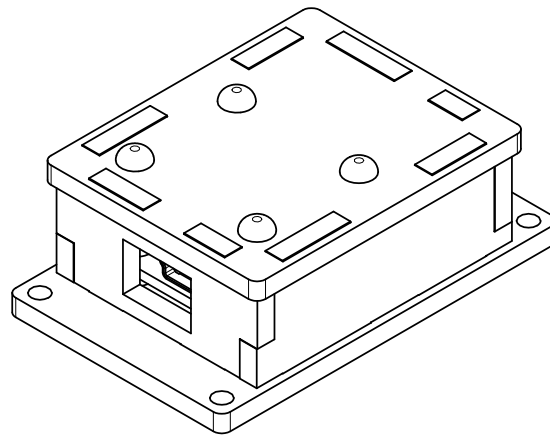

# Contents of Enclosure Kit

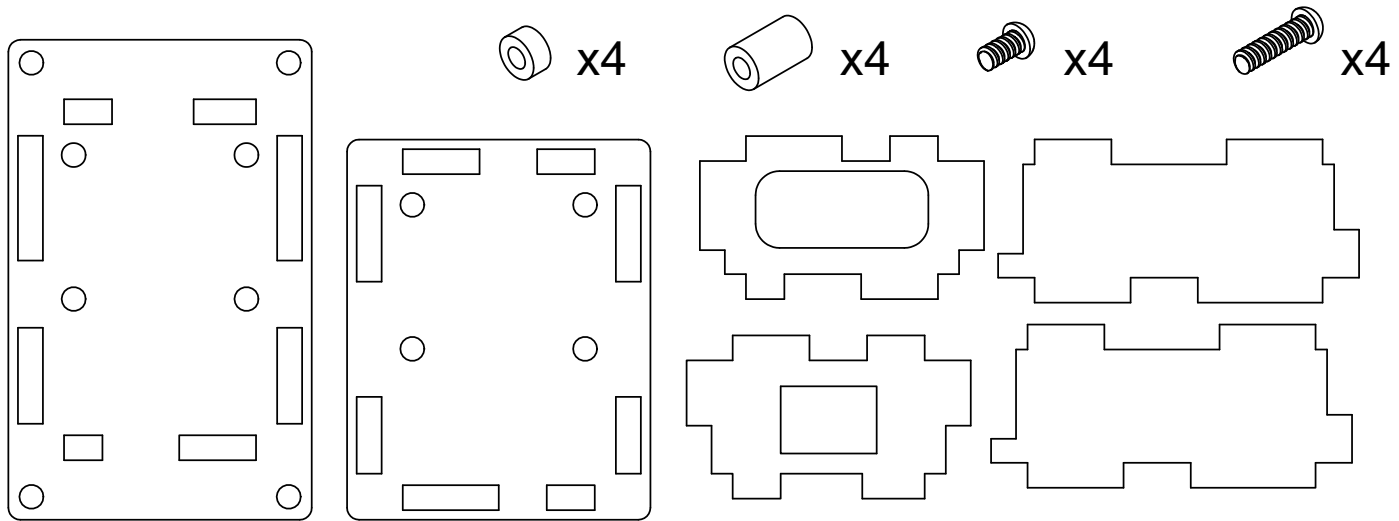

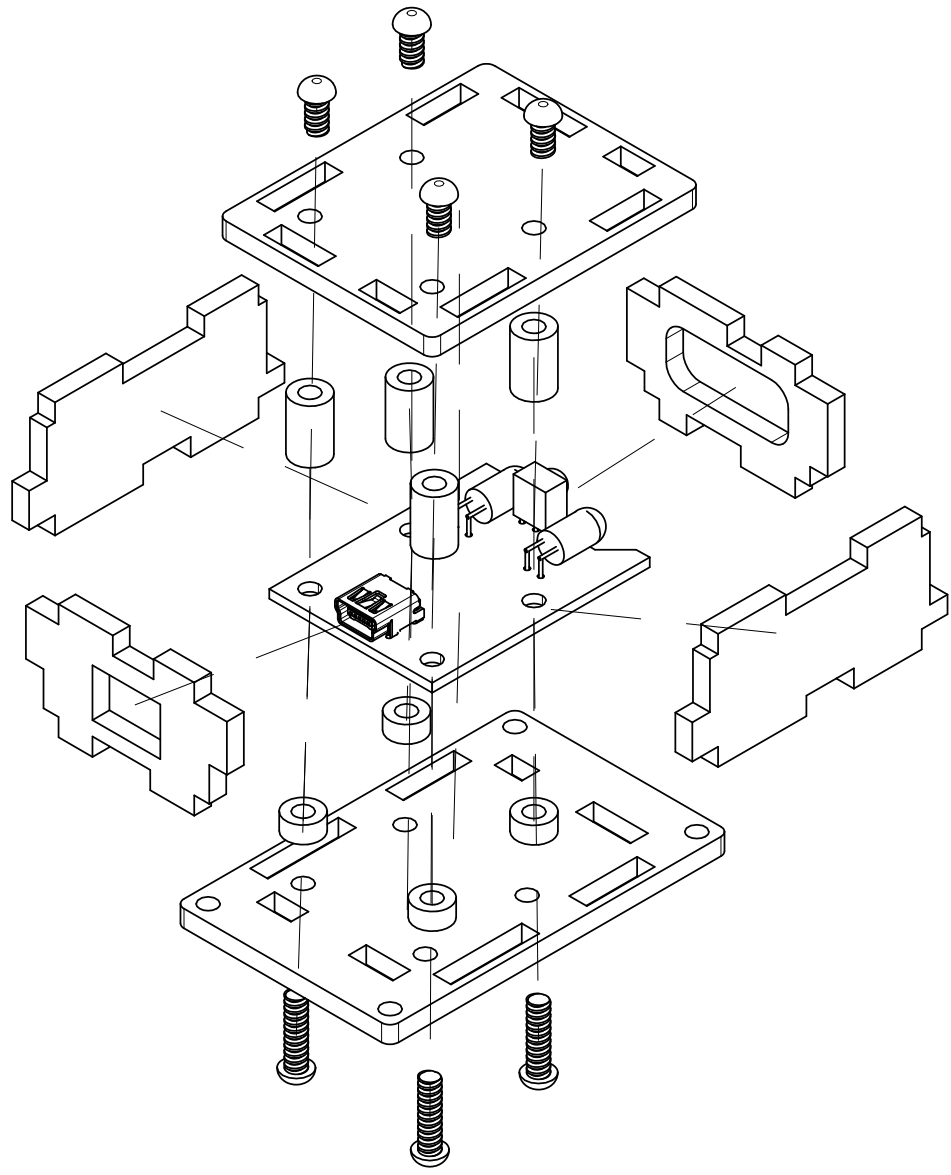

# Assembly Instructions

1

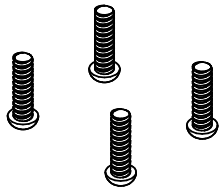

2

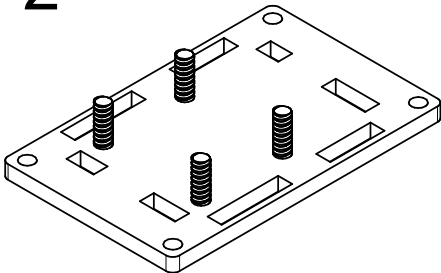

3

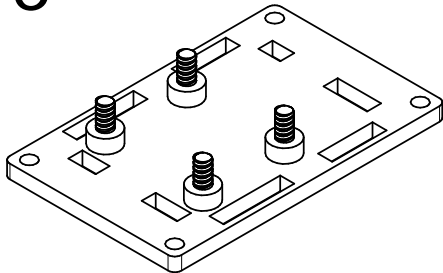

4

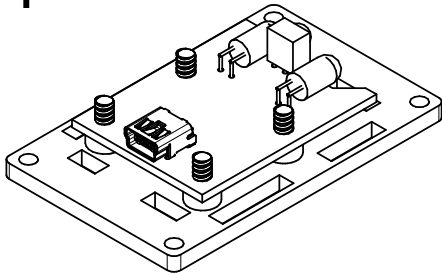

5

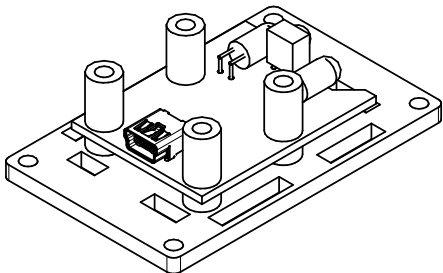

6

