

# 3052\_1 Mechanical Drawing

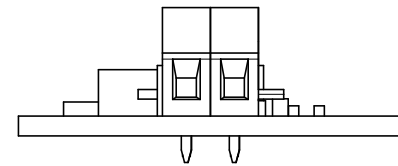
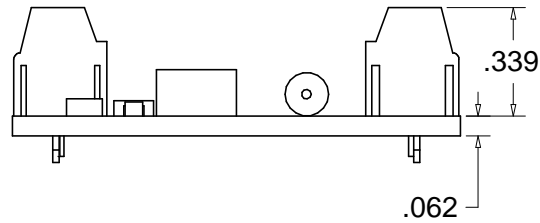
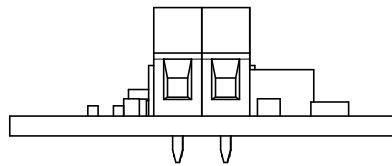
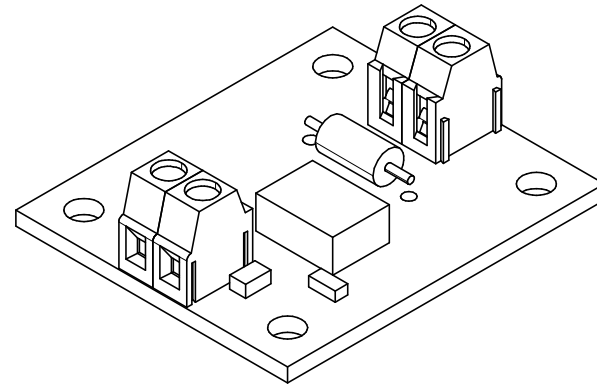
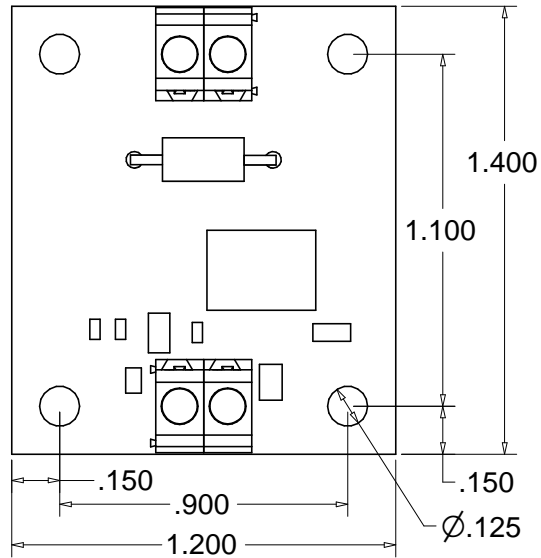

Scale 1: 0.6  
Units are in Inches