

3051_1 Mechanical Drawing

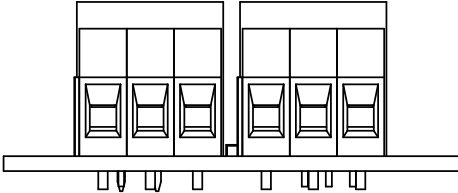
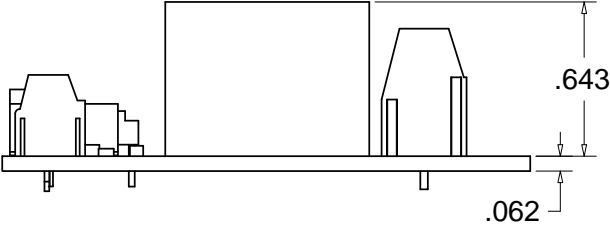
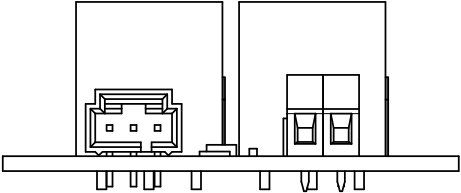
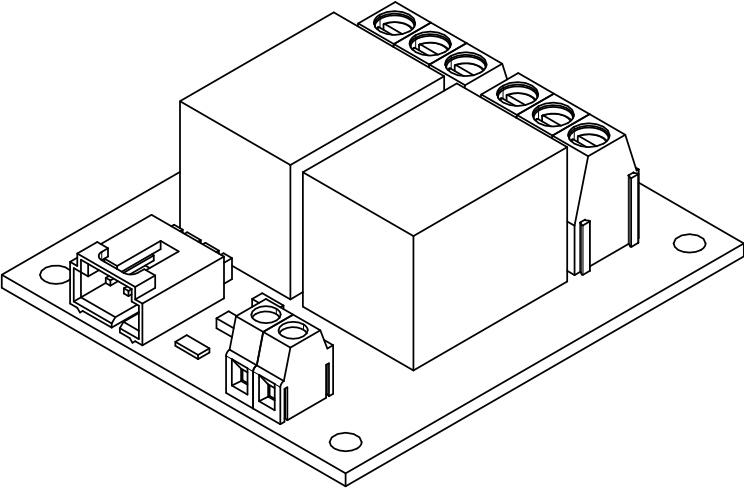
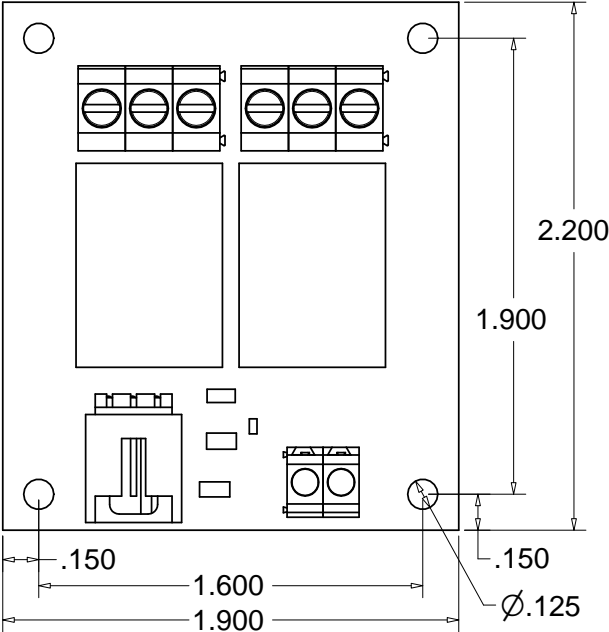

Scale 1:0.8
 Units are in Inches