

# 1140\_0 Mechanical Drawing

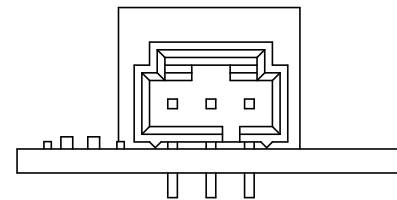
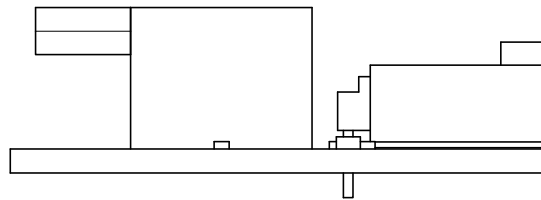
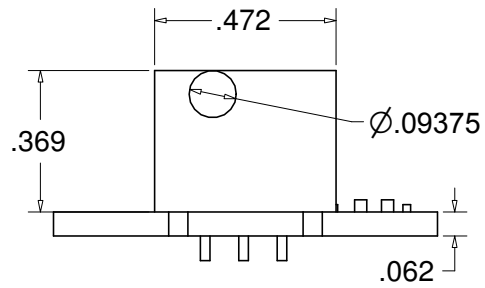
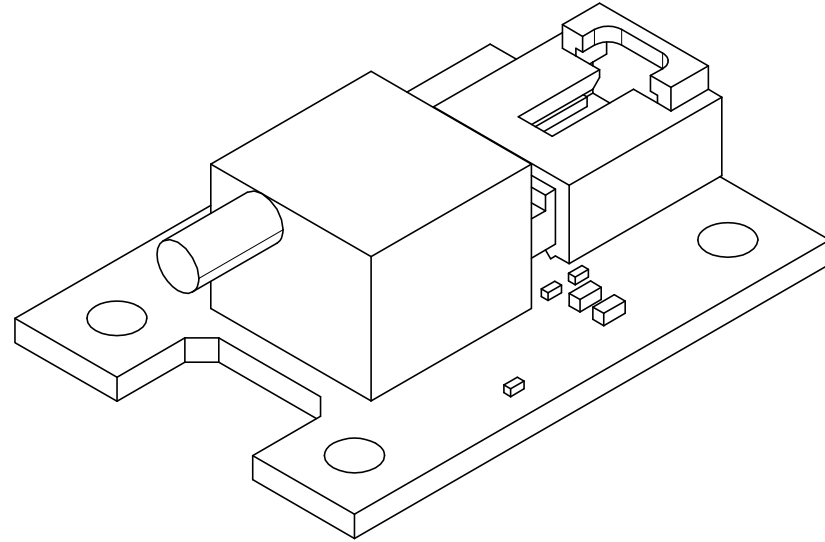
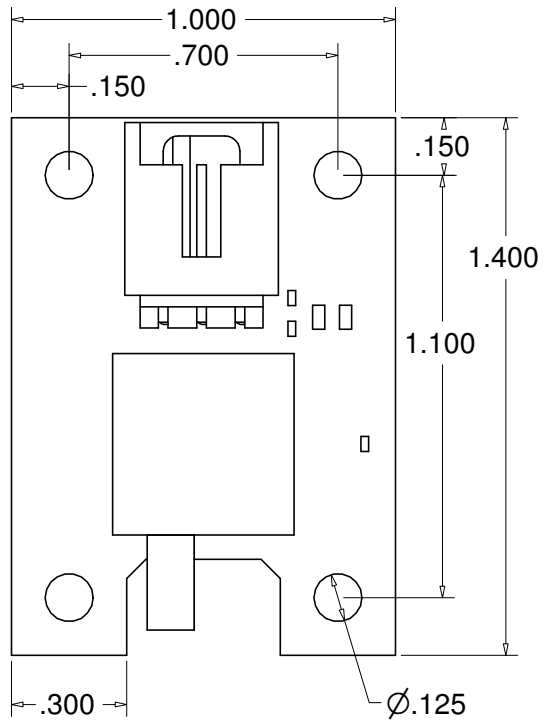

Scale 1: 0.5  
Units are in Inches