

# 1137\_0 Mechanical Drawing

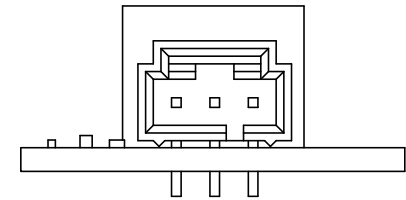
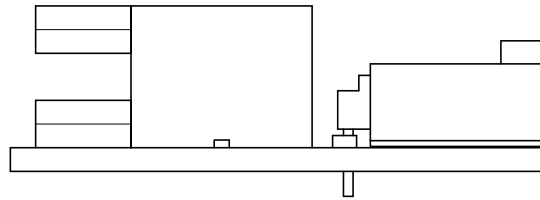
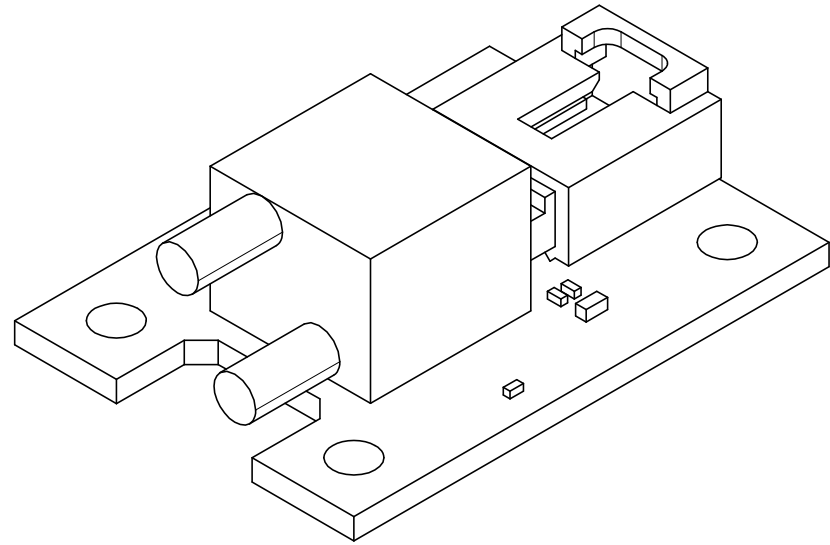
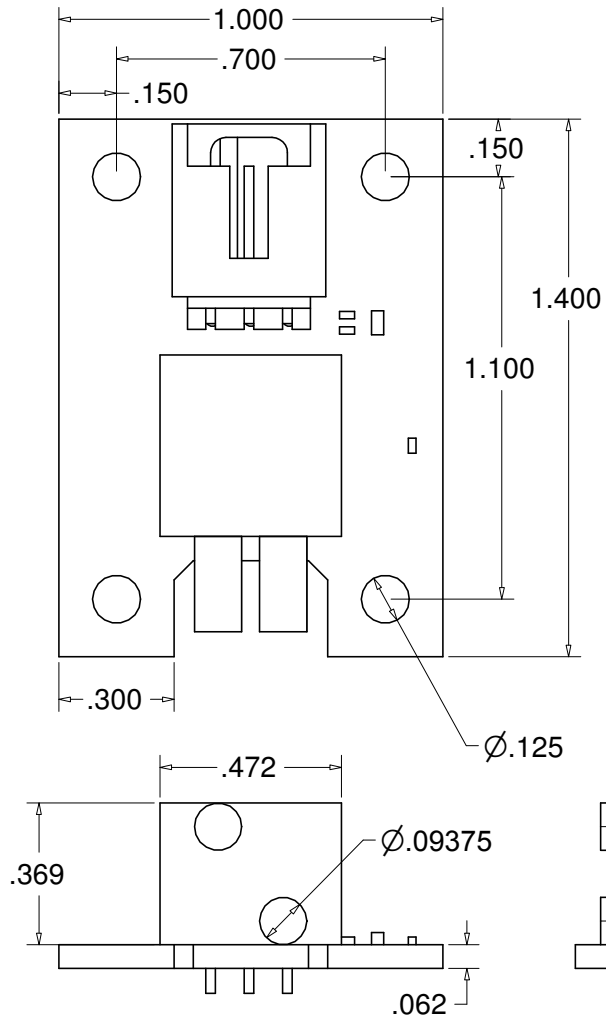

Scale 1: 0.5  
Units are in Inches