

1130_0 Mechanical Drawing

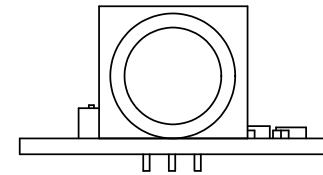
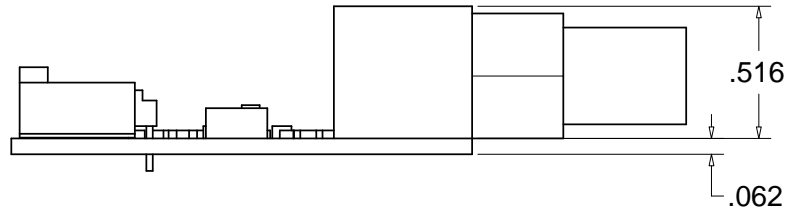
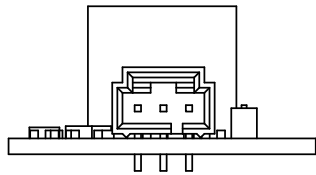
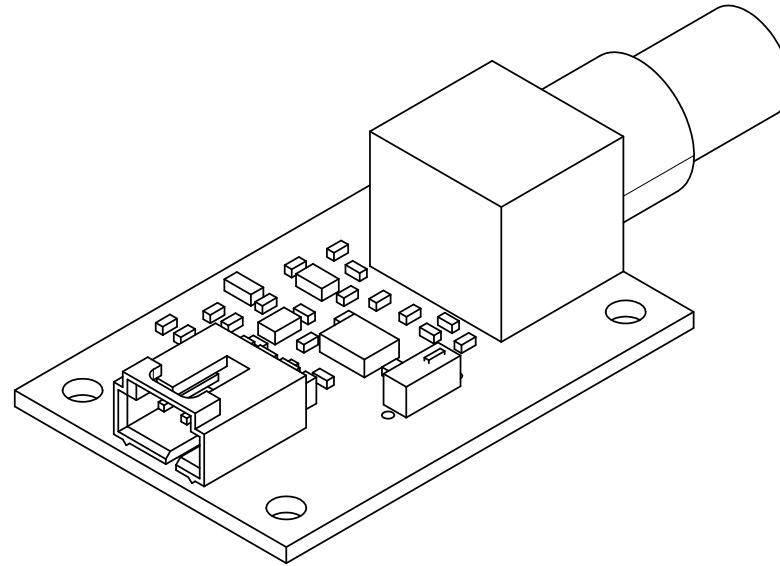
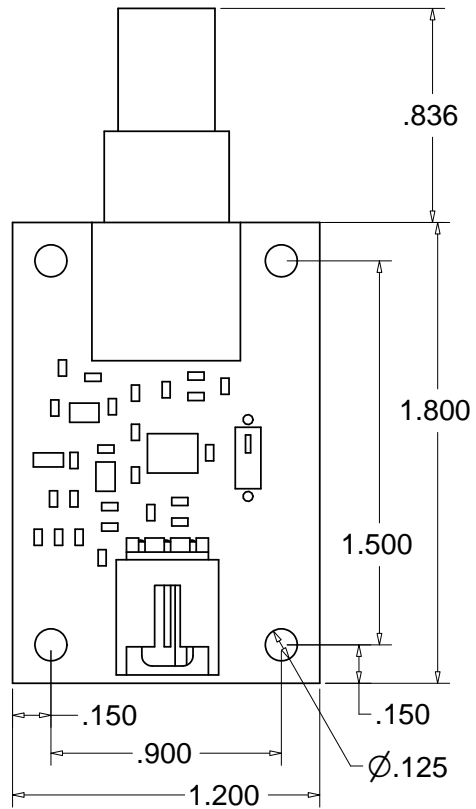

Scale 1:0.75
Units are in Inches