

1129_1 Mechanical Drawing

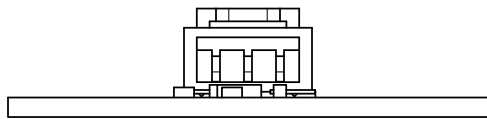
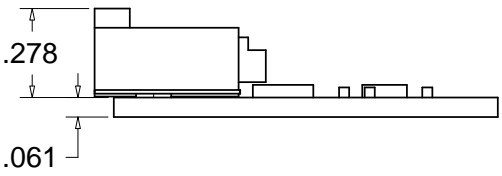
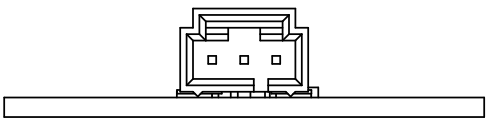
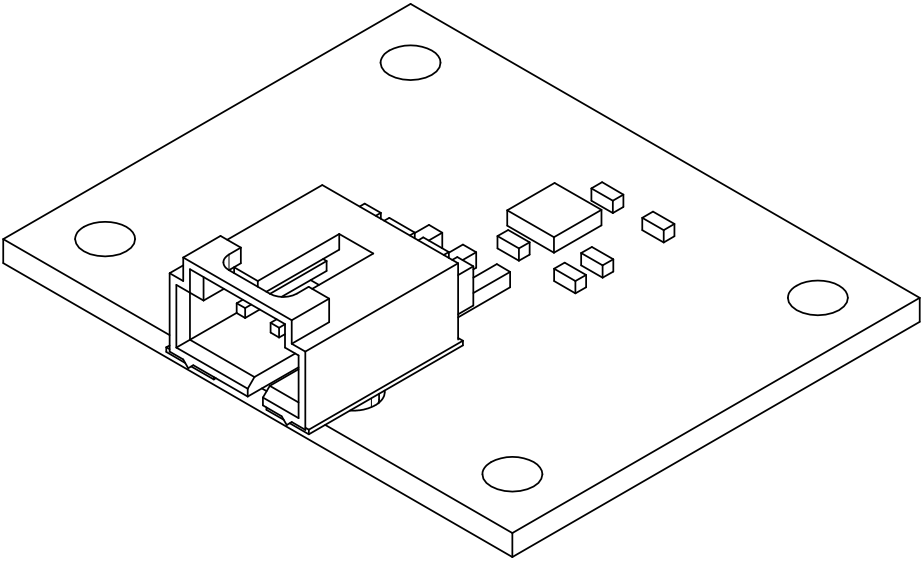
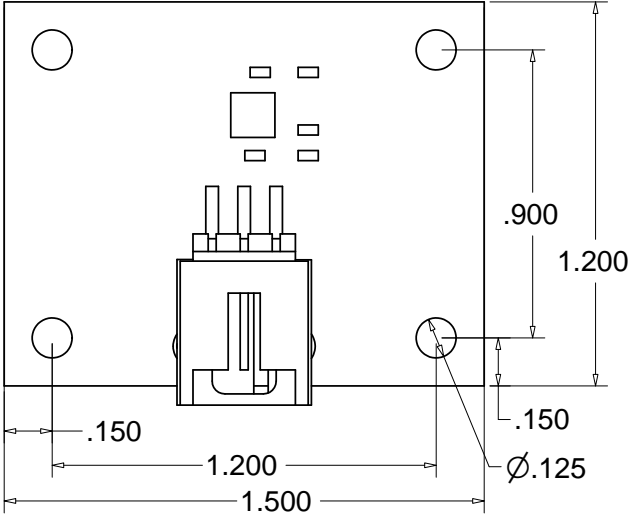

Scale 1:0.6
Units are in Inches