

1126_1 Mechanical Drawing

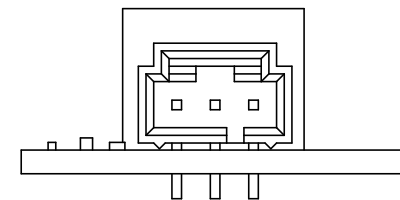
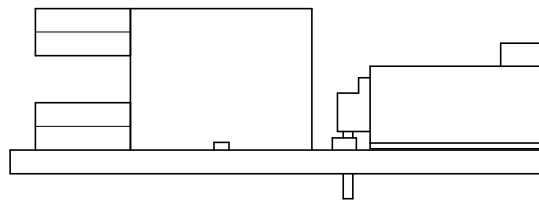
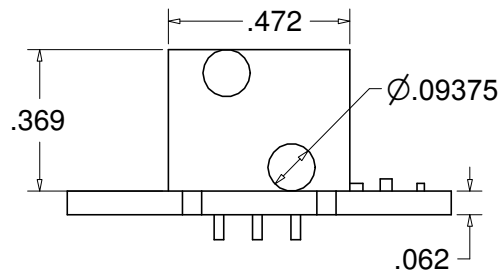
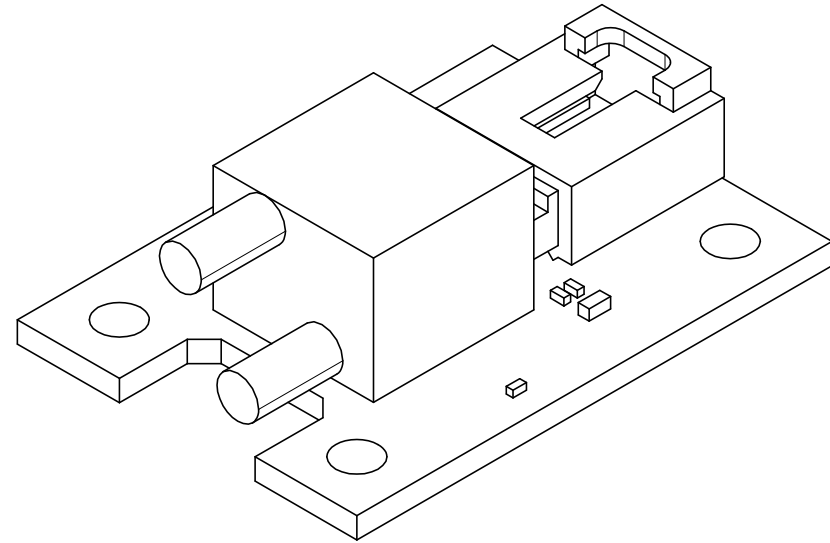
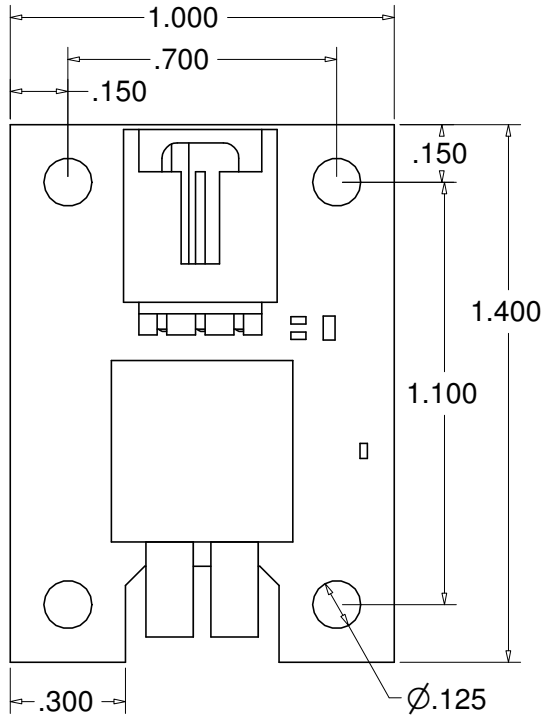

Scale 1: 0.5
Units are in Inches