

# 1124\_0 Mechanical Drawing

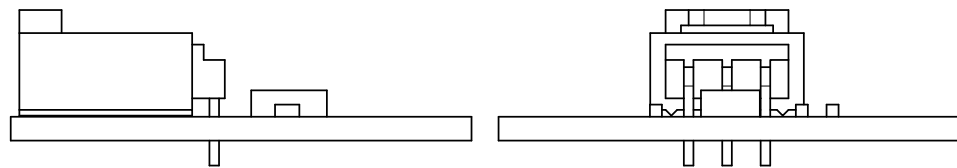
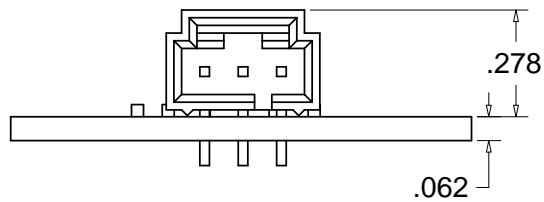
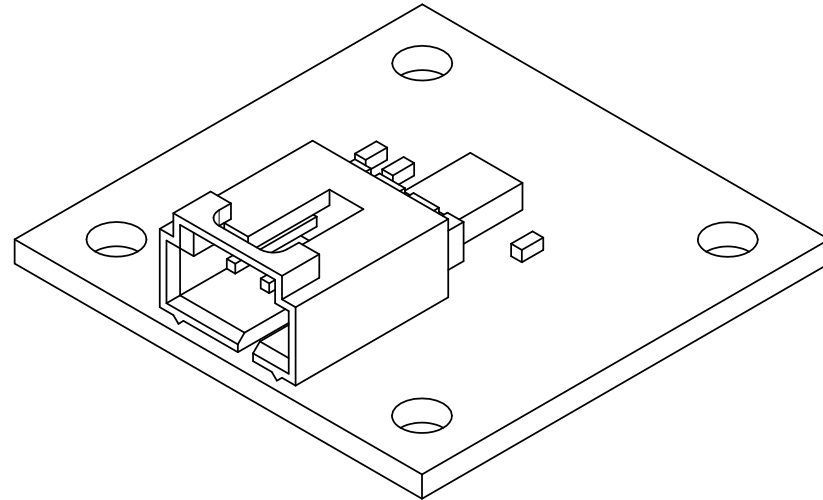
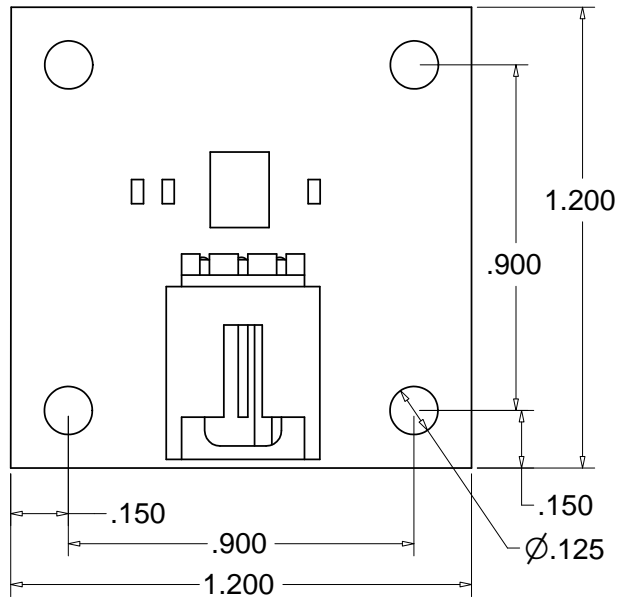

Scale 1:0.5  
Units are in Inches