

# 1112\_1 Mechanical Drawing

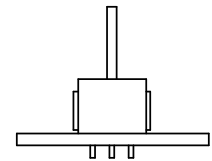
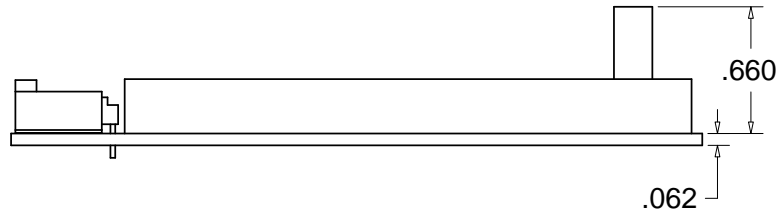
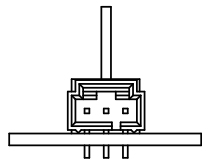
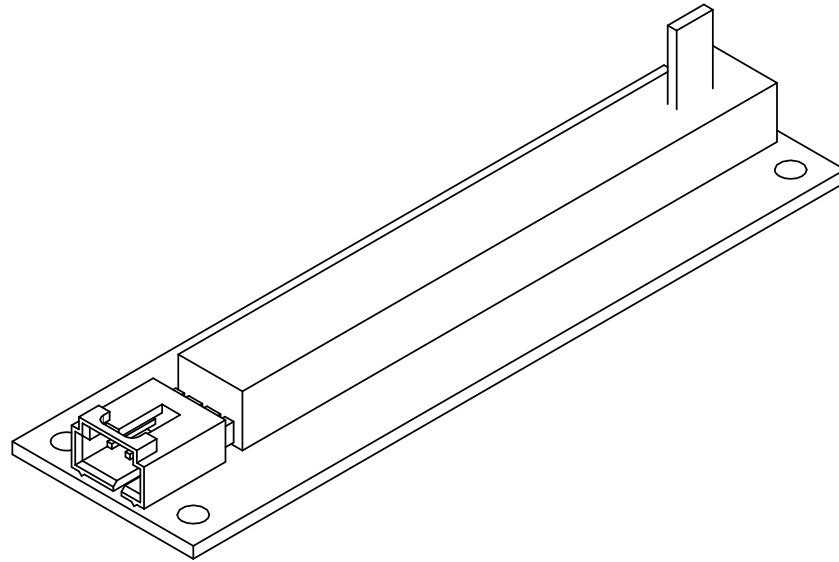
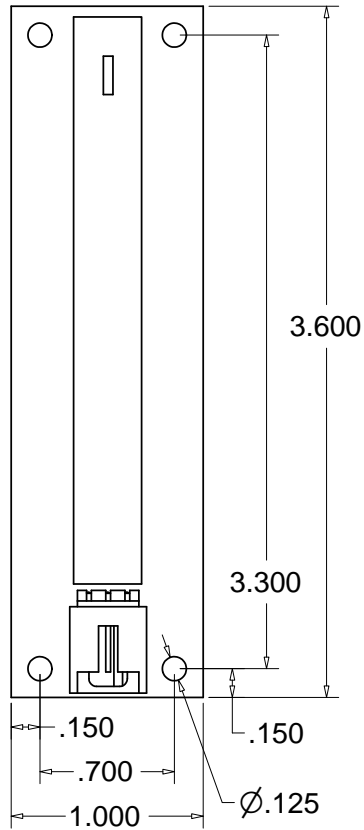

Scale 1:1  
Units are in Inches