

1109_0 Mechanical Drawing

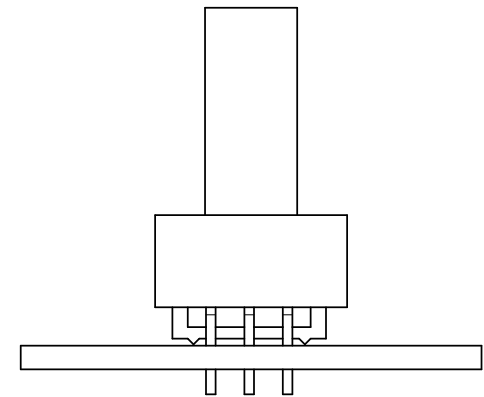
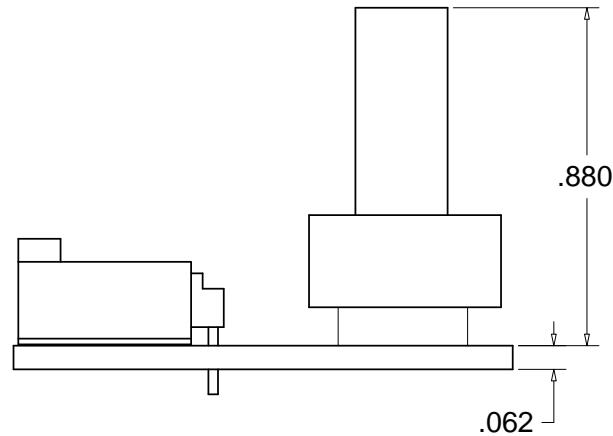
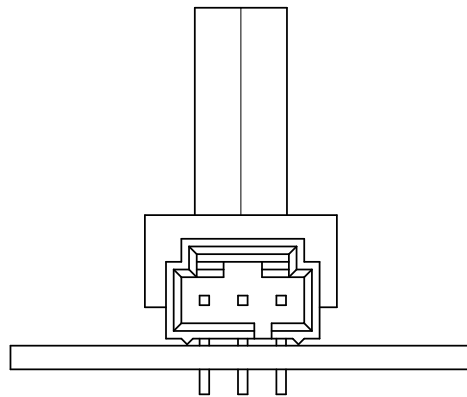
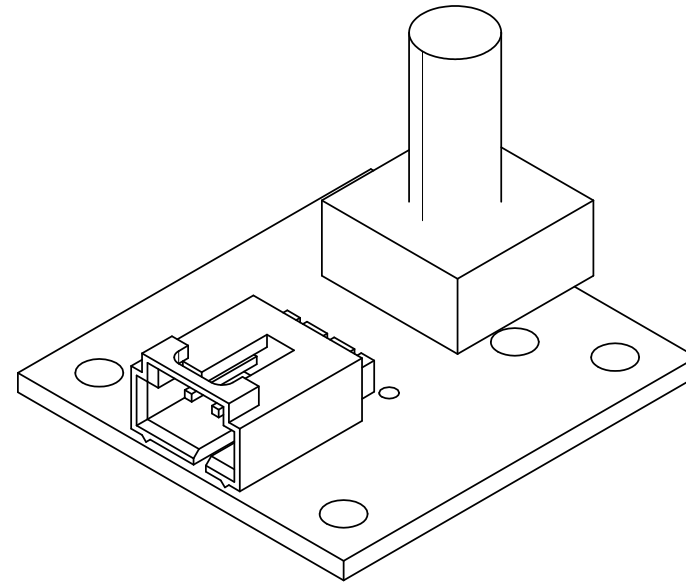
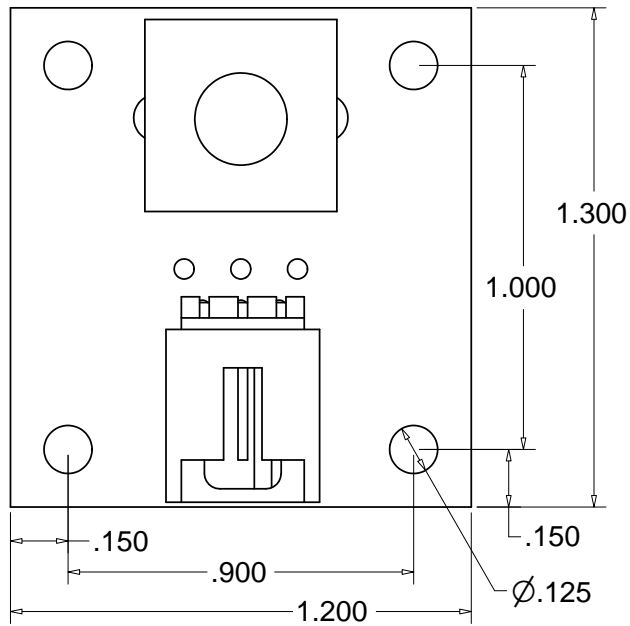

Scale 1:0.5
Units are in Inches