

# 1108\_0 Mechanical Drawing

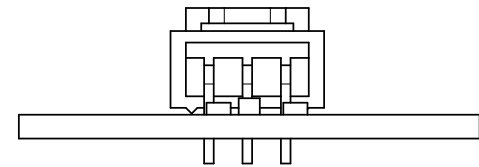
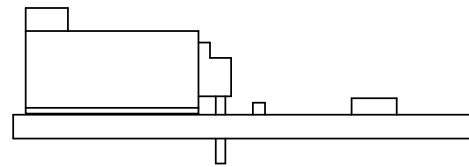
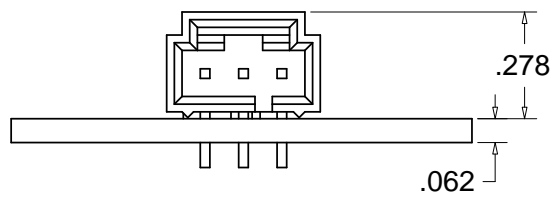
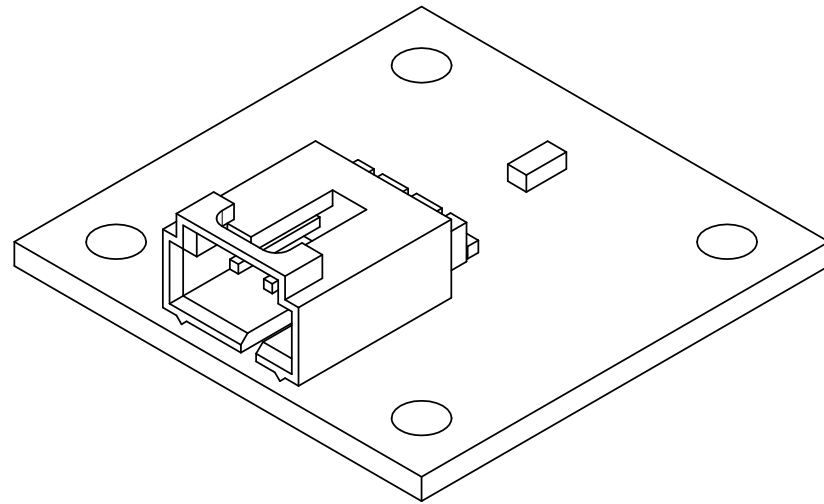
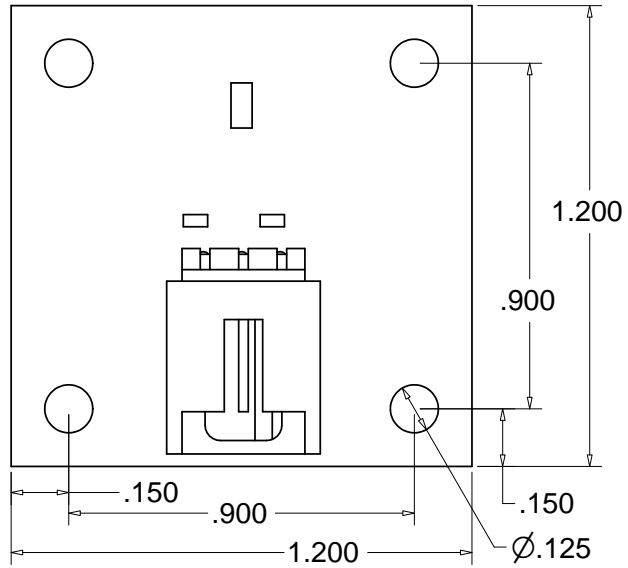

Scale 1:0.5  
Units are in Inches