

# 1041\_0B Mechanical Drawing

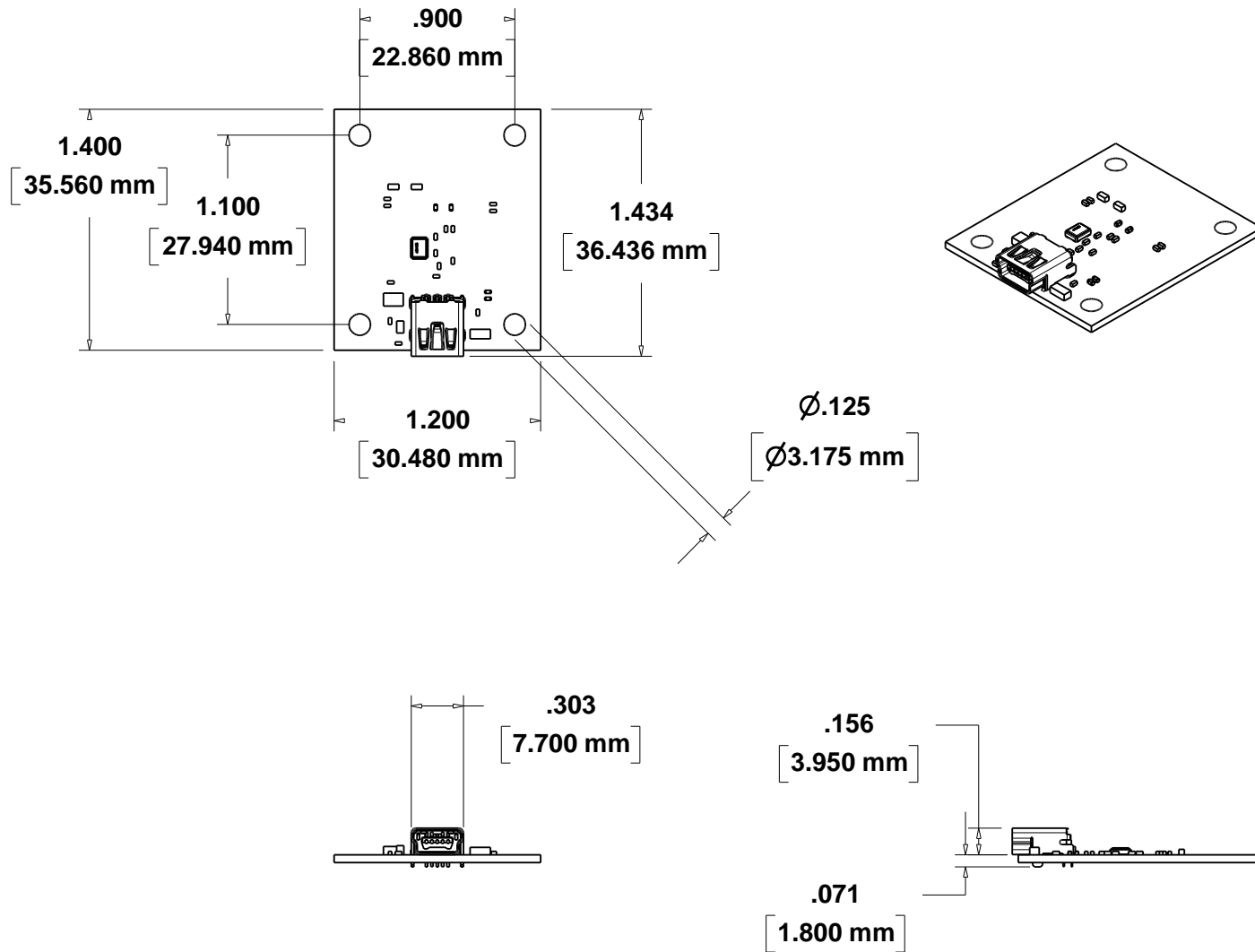

# 1041\_0B Enclosure Mechanical Drawing

