

# 1024\_0 Mechanical Drawing

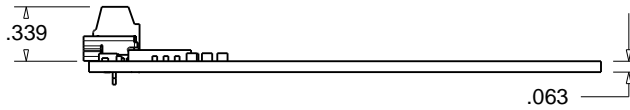
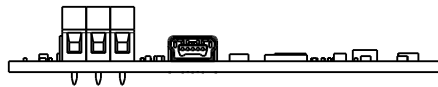
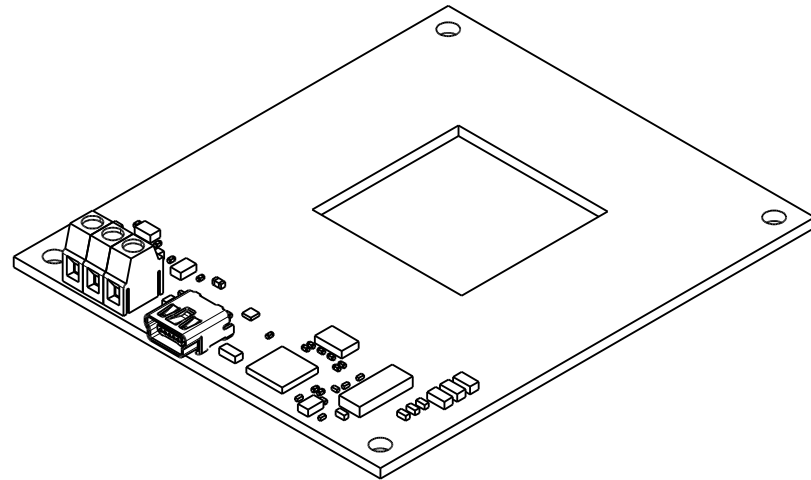
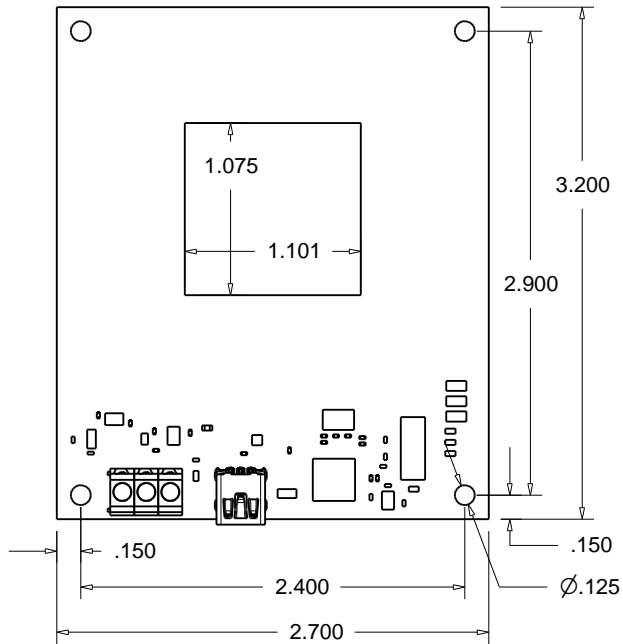

Scale 1:1.2  
Units are in Inches