

1023_1 Mechanical Drawing

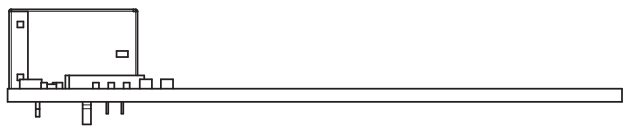
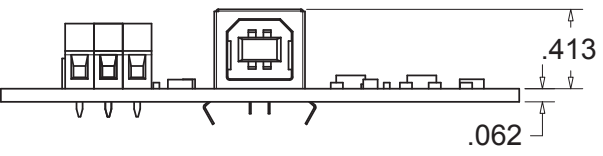
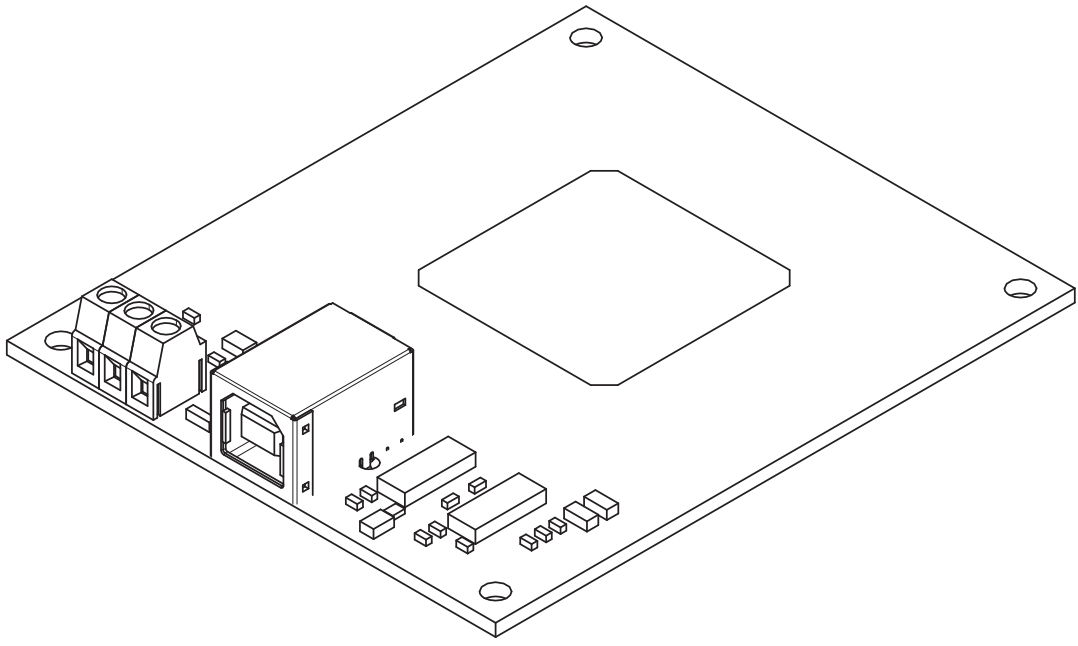
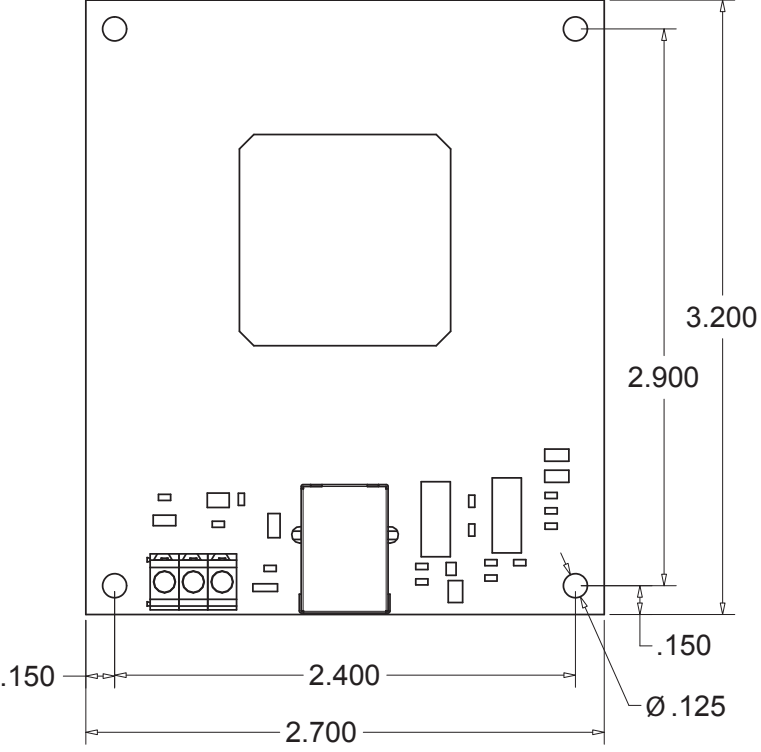

Scale 1:1
Units are in Inches