

1014_2 Mechanical Drawing

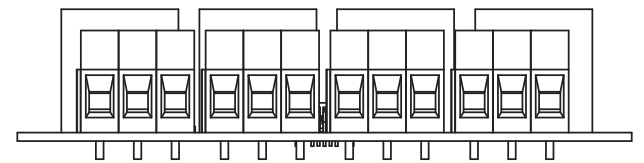
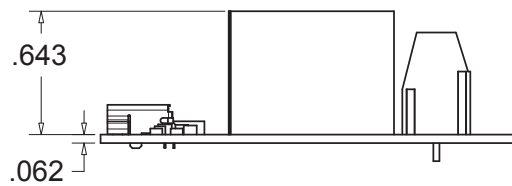
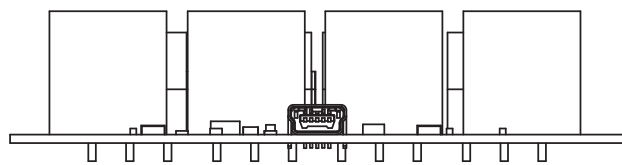
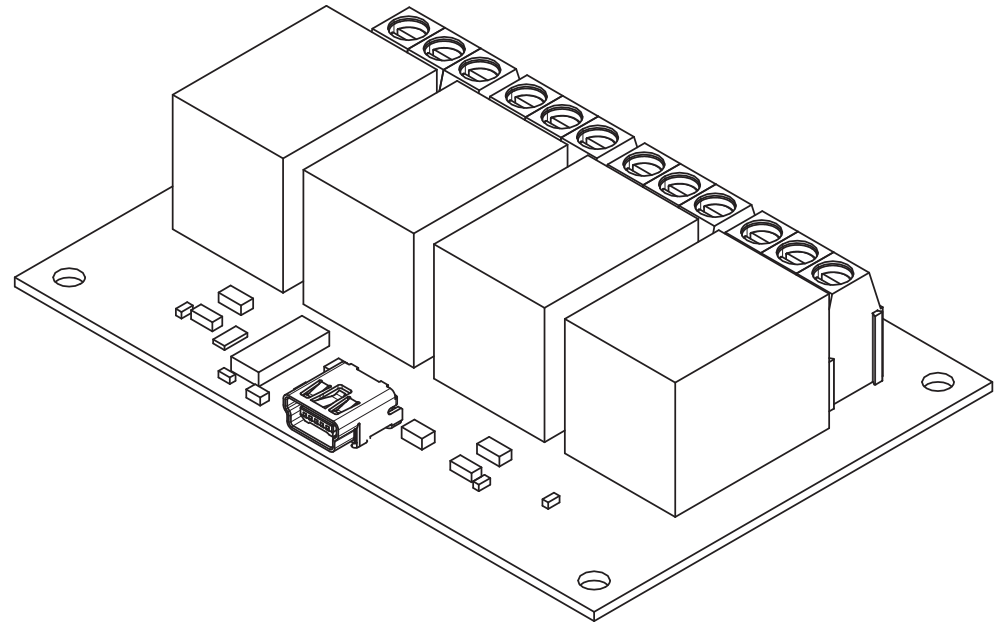
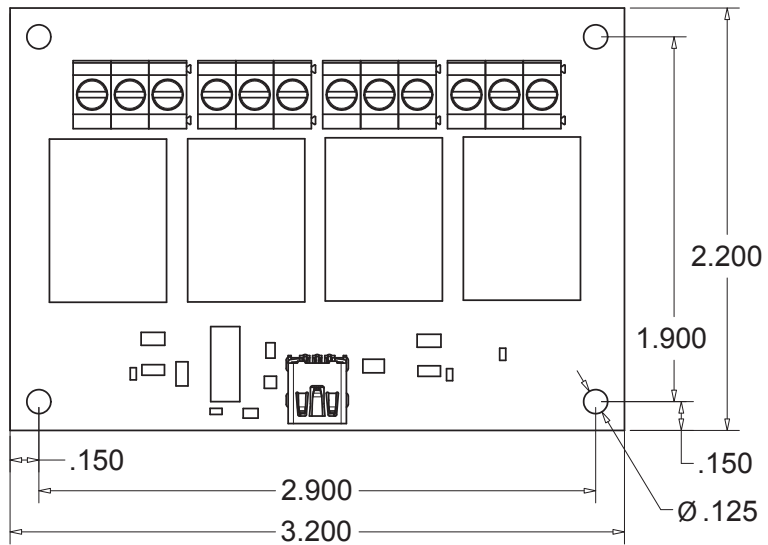

Scale 1:1
Units are in Inches