

1118_0 Mechanical Drawing

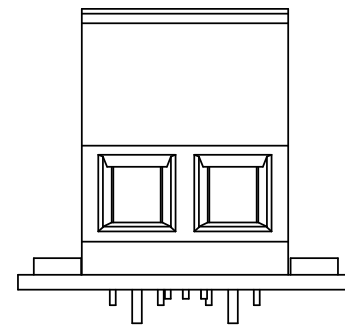
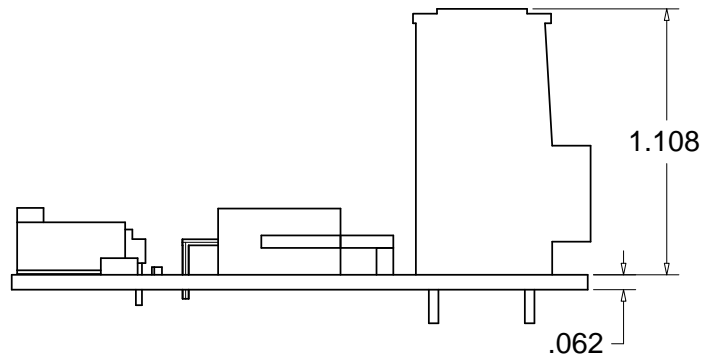
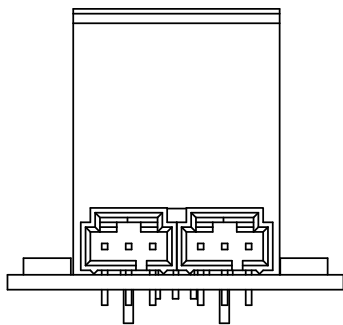
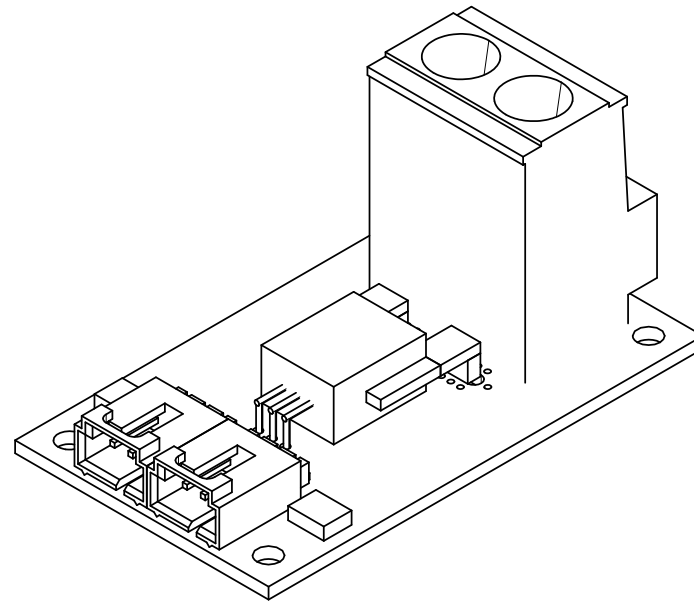
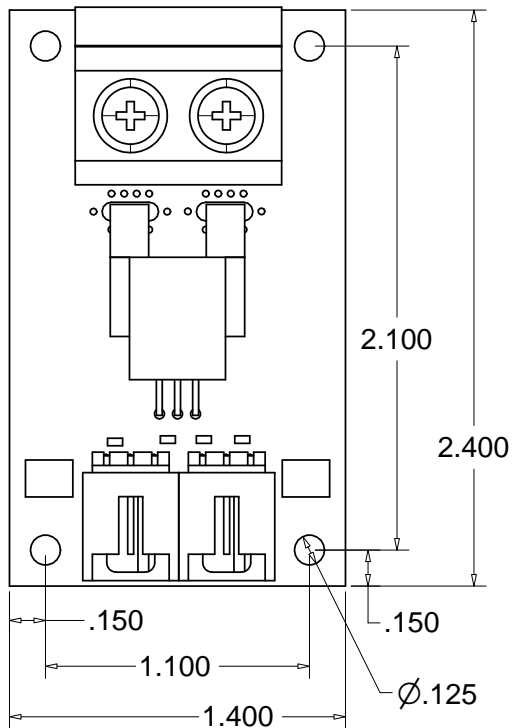

Scale 1:0.8
Units are in Inches