

1063_0 Mechanical Drawing

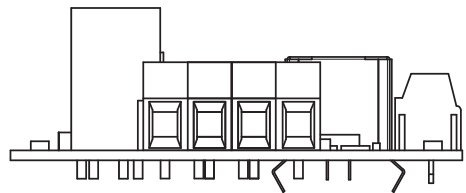
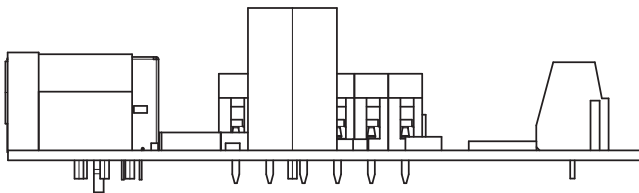
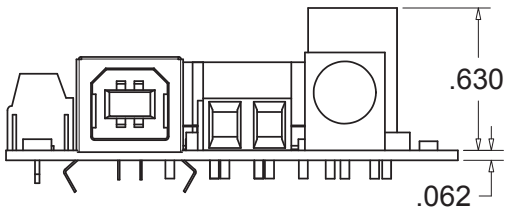
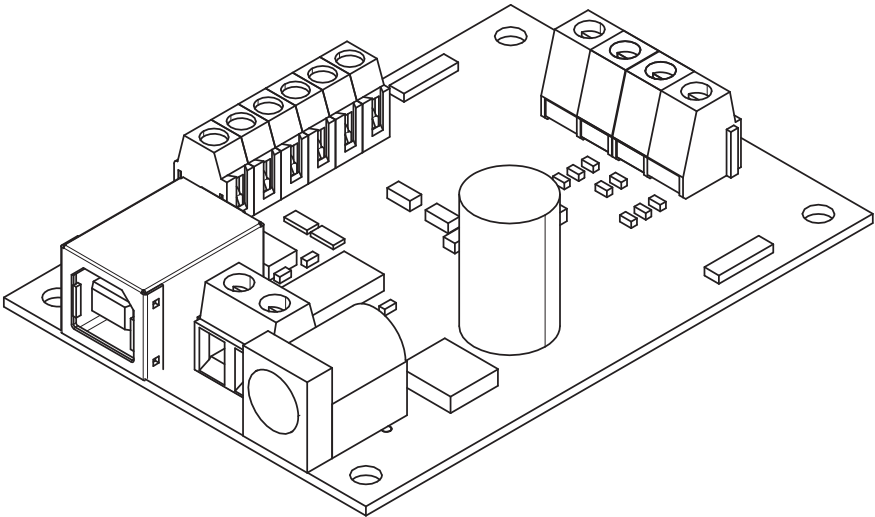
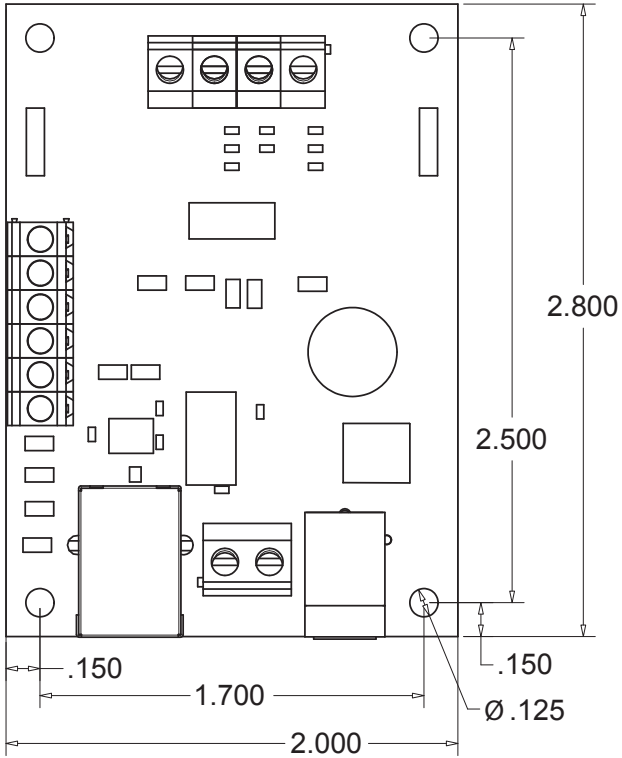

Scale 1:0.85
Units are in Inches