

# 1132\_0 Mechanical Drawing

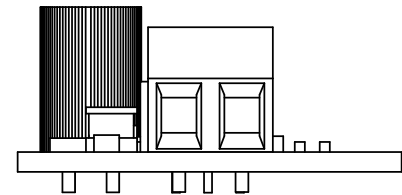
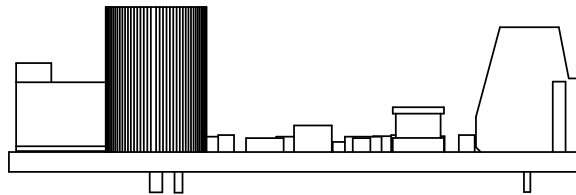
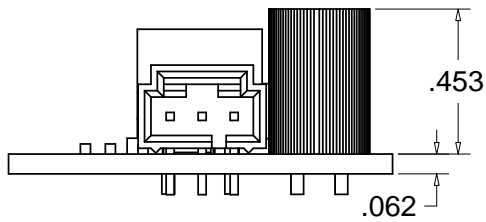
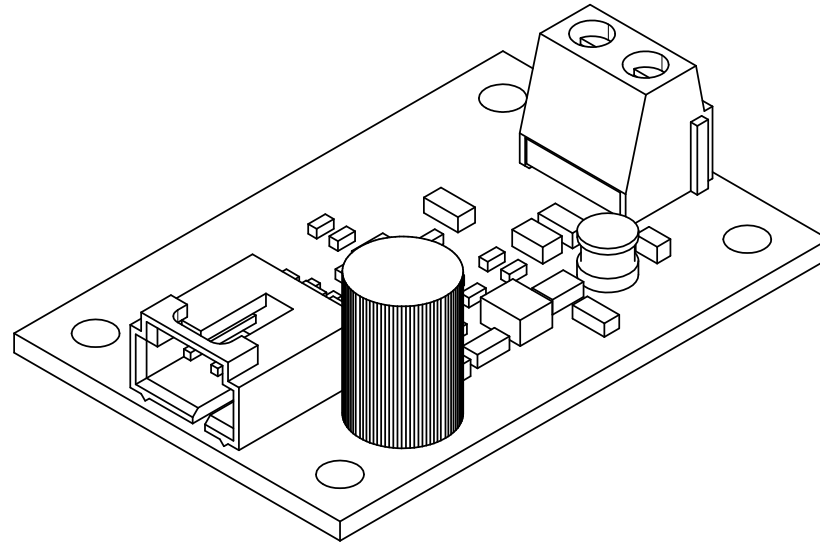
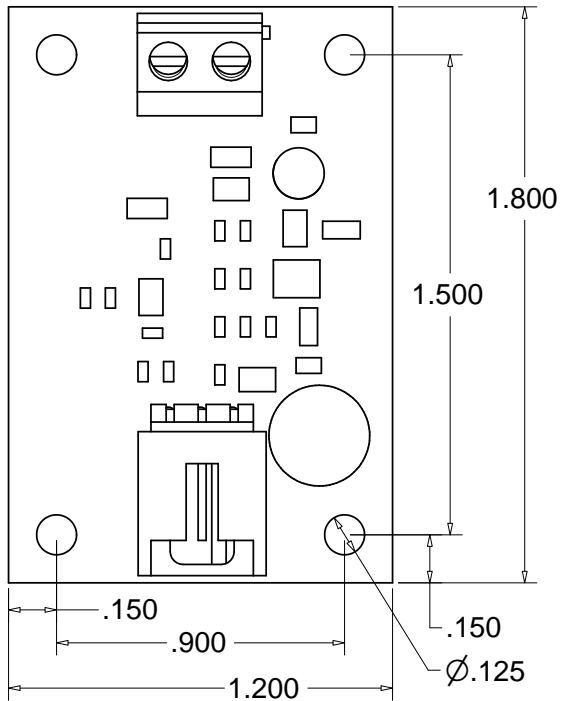

Scale 1:0.6  
Units are in Inches